

# 8x8 HDMI2.0 Matrix

Support 4K@60hz YUV4:4:4, 18Gbps, HDR

## OPERATION MANUAL



---

Thank you for purchasing this product. For optimum performance and safety, please read these instructions carefully before connecting, operating or adjusting this product. Please keep this manual for future reference.

## **SAFETY PRECAUTIONS**

Please read all instructions before attempting to unpack, install or operate this equipment and before connecting the power supply.

Please keep the following in mind as you unpack and install this equipment:

- Always follow basic safety precautions to reduce the risk of fire, electrical shock and injury to persons.
- To prevent fire or shock hazard, do not expose the unit to rain, moisture or install this product near water.
- Never spill liquid of any kind on or into this product.
- Never push an object of any kind into this product through any openings or empty slots in the unit, as you may damage parts inside the unit.
- Do not attach the power supply cabling to building surfaces.
- Use only the supplied power supply unit (PSU). Do not use the PSU if it is damaged.
- Do not allow anything to rest on the power cabling or allow any weight to be placed upon it or any person walk on it.
- To protect the unit from overheating, do not block any vents or openings in the unit housing that provide ventilation and allow for sufficient space for air to circulate around the unit.

# CONTENTS

|   |    |
|---|----|
| 1. INTRODUCTION.....                            | 4  |
| 2. APPLICATIONS.....                            | 4  |
| 3. PACKAGE CONTENTS.....                        | 4  |
| 4. SYSTEM REQUIREMENTS.....                     | 4  |
| 5. FEATURES.....                                | 5  |
| 6. SPECIFACATIONS.....                          | 5  |
| 7. OPERATION CONTROLS AND FUNCTIONS.....        | 6  |
| 7.1 Front Panel.....                            | 6  |
| 7.2 Rear Panel.....                             | 6  |
| 7.3 LCD screen introduction.....                | 7  |
| 7.3.1 Input / output channel key operation..... | 7  |
| 7.3.2 Video switching operation.....            | 8  |
| 7.3.3 Output Audio on/off control.....          | 10 |
| 7.3.4 Input signal control.....                 | 11 |
| 7.4 Preset scene settings.....                  | 15 |
| 7.5 System configuration.....                   | 16 |
| 7.5.1 RS232 parameter settings.....             | 18 |
| 7.5.2 LCD screen settings.....                  | 19 |
| 7.5.3 Menu settings.....                        | 21 |
| 7.5.4 User EDID settings.....                   | 22 |
| 7.5.5 System settings.....                      | 23 |
| 7.6 Device information query.....               | 25 |
| 7.7 Remote Control Description.....             | 29 |
| 8. AUDIO INTRODUCTIONS.....                     | 30 |
| 8.1 HDMI audio.....                             | 30 |
| 8.2 Audio extraction.....                       | 30 |
| 8.2.1 Analog audio extraction.....              | 30 |
| 8.2.2 SPDIF audio extraction.....               | 30 |
| 8.3 Audio embedded.....                         | 30 |
| 8.4 ARC audio.....                              | 30 |
| 9. EDID MANAGEMENT.....                         | 31 |
| 10. RS232 CONTROL.....                          | 32 |
| 11. WEB CONTROL.....                            | 34 |
| 11.1 Address Information.....                   | 34 |
| 11.2 Change the IP address of your PC.....      | 34 |
| 12. STATUS INTERFACE.....                       | 36 |
| 12.1 Input interface.....                       | 37 |
| 12.2 Output interface.....                      | 39 |
| 12.3 Matrix interface.....                      | 40 |
| 12.4 Preset interface.....                      | 40 |
| 12.5 CEC control interface.....                 | 41 |
| 12.6 System interface.....                      | 42 |
| 13. FIRMWARE UPGRADE.....                       | 44 |
| 14. CONNECTION DIAGRAM.....                     | 45 |
| MAINTENANCE.....                                | 46 |
| PRODUCT SERVICE.....                            | 46 |
| WARRANTY.....                                   | 47 |

## **1. INTRODUCTION**

This 8x8 4k HDMI Matrix supports the transmission of video (resolutions up to 4K2K@60Hz, HDCP 2.2, HDMI2.0) and multi- channel digital audio from 8 HDMI sources to 8 HDMI outputs and 8 SPDIF Output. This matrix supports high resolution digital audio formats such as Dolby TrueHD and DTS-HD Master Audio as well as 3D video content. In addition, this matrix also allow Analog audio embed and extract from 8 Analog audio inputs and 8 Analog audio outputs.

Controllable via Panel buttons, local IR, RS-232, IP or Web GUI. We can provide control drivers for all the major control systems. This unit also supports HDR10 to bring ultimate visual experience. It is designed to save end users' time and energy for they are able to update the system by the creative RS232 interface.

## **2. APPLICATIONS**

- Video/TV wall display and control
- Security surveillance and control
- Commercial advertising, display and control
- University lecture hall, display and control
- Retail sales and demonstration

## **3. PACKAGE CONTENTS**

- 1x HDMI Matrix
- 1x DC12V 3A power supply
- 1x Remote control
- 1x IR Ext RX Cable
- 1x mounting kit
- 1x CD for control software & user manual

## **4. SYSTEM REQUIREMENTS**

- HDMI source equipment such as media players, game consoles or set-top boxes.
- HDMI receiving equipment such as HDTV, monitors or audio amplifiers.
- The use of "Premium High Speed HDMI" cables is highly recommended

## 5. FEATURES

- HDMI 2.0 version (Support 4K@60Hz YUV4:4:4)
- Support 3D
- Bandwidth upto 18Gbps
- HDCP1.4/2.2 compliant
- Support HDR10, HLG, Dolby Vision
- 8xHDMI Input, 8xHDMI output
- 8xAnalog audio input and 8xAnalog audio output, and 8xS/PDIF audio output
- Support Analog audio embedded and HDMI audio extraction
- Any one of the 8 Ultra HD sources to any one of the 8 Ultra HD displays
- Support LPCM2.0-5.1/16-24BIT/32-192KHZ, Dolby Atmos and DTS-X
- RS232 interface for user to upgrade firmware
- Controllable via front-panel buttons, IR remote, RS232, IP , Web GUI
- The Ethernet port supports Telnet, UDP, HTTP, and TCP/IP
- Support EDID management, CEC and ARC

## 6. SPECIFACATIONS

|                            |  |
|----------------------------|--|
| Bandwidth                  | 18 Gbps  |
| Resolution                 | 480p@60hz,576P@50hz,720P@60hz,<br>1080P@24hz,1080P@50hz,1080P@60hz,4K@24hz,4K@30hz,<br>4K@60hz YUV4:2:0, 4K@ 60hz YUV4:4:4 |
| Video Input Connectors     | 8xHDMI Type A, 19-pin, female  |
| Video Output Connectors    | 8xHDMI Type A, 19-pin, female  |
| Audio Input Connectors     | 8xAnalog audio, 3.5mm, female  |
| Audio Output Connectors    | 8xAnalog audio, 3.5mm, female, 8x SPDIF Coaxial, female  |
| RS-232 serial port         | DB9, female  |
| Ethernet port (IP control) | RJ45, female   |
| IR Ext port                | 1x3.5mm stereo jack  |
| Dimensions(WxHxD)          | L482.4 XW 220 XH44 mm  |
| Net Weight                 | 2.8kg  |
| Operating Temperature      | 32°F to 104°F (0°C to 40°C)  |
| Storage Temperature        | 14°F to 140°F (- 10°C to 60°C)   |
| Power consumption          | 28W(Max)   |

## 7. OPERATION CONTROLS AND FUNCTIONS

### 7.1 Front Panel

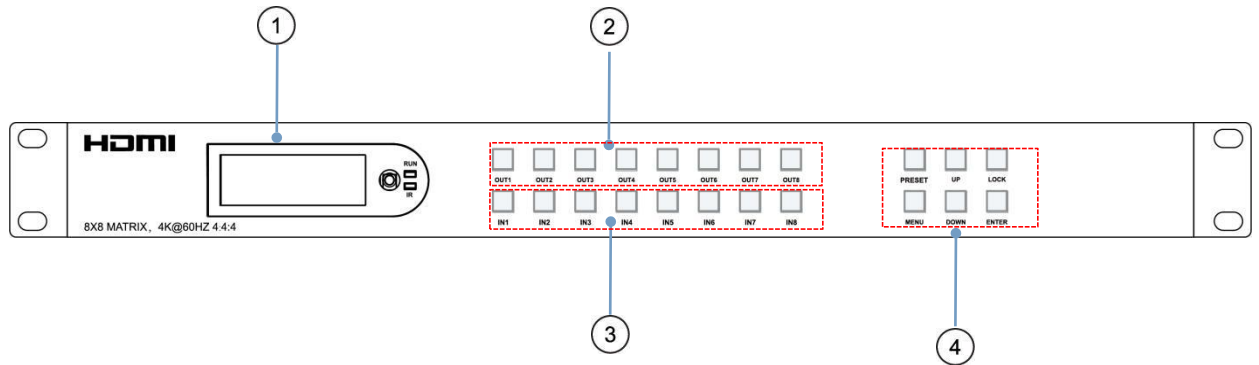

- ① LCD: Showing Matrix information
- ② Output button OUT1~8
- ③ Input button IN1~8
- ④ Function button: PRESET; MENU; UP; DOWN; LOCK; ENTER

### 7.2 Rear Panel

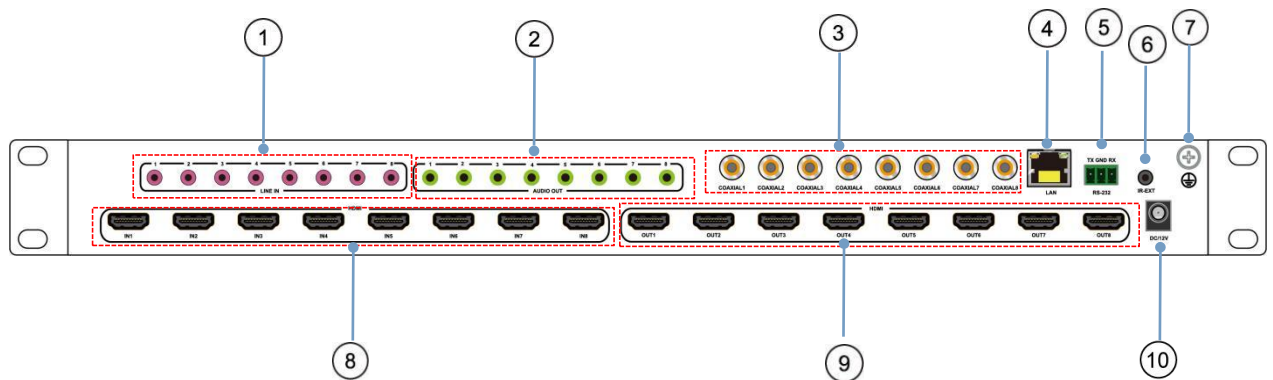

- ① AUDIO IN (Analog x8)
- ② AUDIO OUT (Analog x8)
- ③ AUDIO OUT (SPDIF x8)
- ④ Ethernet port
- ⑤ RS232
- ⑥ IR port
- ⑦ Grounding
- ⑧ HDMI Input ×8
- ⑨ HDMI Output×8
- ⑩ Power on/off

### 7.3 LCD screen introduction



Device Startup interface(picture-1)

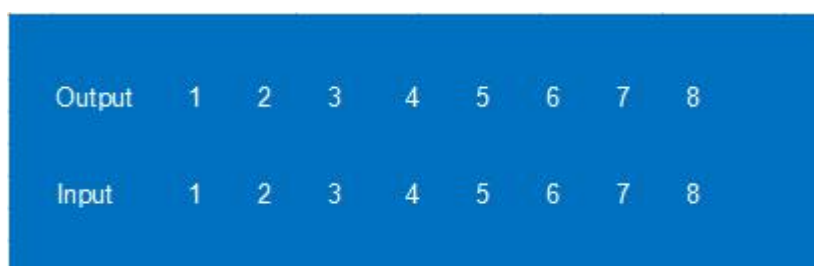

Channel interface (picture-2)

#### 7.3.1 Input / output channel key operation

| Channel    | Button method  |
|------------|--|
| Any Key    | The first operation of the button can wake up the screen and complete the key function while the blue button light will light up.  |
| Input 1-8  | Directly press the number key, such as input channel 1, and select "1" to press (only when the output port is selected, the input channel number will be valid)  |
| Output 1-8 | Directly press the number key, such as the output channel 5, select the key "5" and press it again to cancel the selection; Long press output any channel number to select all channels, and long press again to cancel. After press the button, no next operation is performed within 10 seconds, and the operation state ends. |
| MENU       | Function Button; Enter the function option or back to previous option. Long press back to function option, the next step is not performed for 30 seconds, screen back to select channel interface  |
| ENTER      | Confirm Button: enter function selection mode  |
| UP         | Button for UP option   |
| DOWN       | Button for NEXT option   |
| PRESET     | Quick selection scene button   |
| LOCK       | Long press lock (button built-in blue light on), Long press again to cancel lock (button built-in blue light off)  |

### 7.3.2 Video switching operation

The signal switch includes 8 free switching channels, which can be configured as input/output according to the requirements, forming a matrix of 1 x 8 ~ 8 x 1, which can switch any input. Signal to 1 channel output or all channel output.

The specific operation is as follows:

|        |   |   |   |   |   |   |   |   |
|--------|---|---|---|---|---|---|---|---|
| Output | 1 | 2 | 3 | 4 | 5 | 6 | 7 | 8 |
| Input  | 1 | 2 | 3 | 4 | 5 | 6 | 7 | 8 |

Video switching mode (picture-3)

Switch the input to the output

Operation format: "output channel" + "input channel"

For Example: Output port 1,3,4 switch to input 3

Operation: Press OUT number "2" "5" "8" + IN number "7" to complete the switch

For Example: Switch all outputs to input 4

Operation: Long press input number "4" to complete the switch

### Output signal Control

Output interface has nine sub-menus: Output1-Output8 and All, switch the video source of the output port and turn on/off the output audio video signal

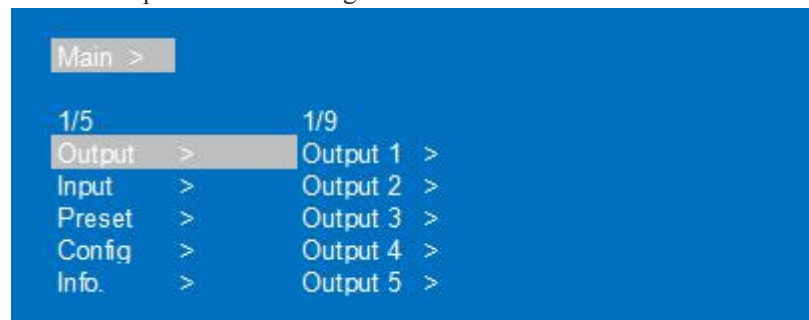

Output menu interface(picture-4)



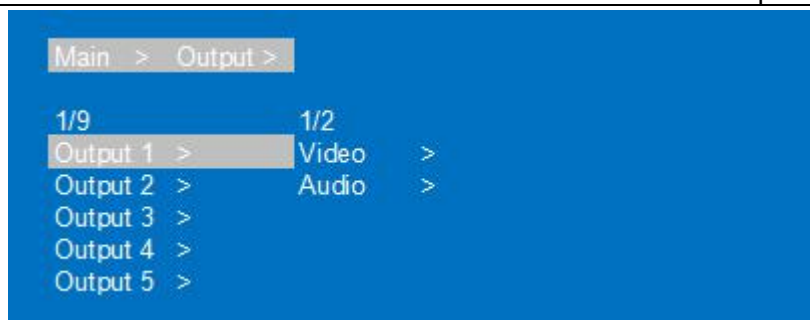

Output port menu interface(picture-5)

### Output video switch and on/off

Switch any output to one input, or switch all outputs to one input; Default 8×8 matrix, 8 inputs and 8 outputs, one to one output

Operation instructions:

- ① Select “Output” in the menu and press “ENTER”
- ② Then use “UP” “DOWN” button to select “output 1~8 or All”, The bottom color of the selected output port becomes white.
- ③ Press “Enter” enter next page.
- ④ Press “UP” “DOWN” button to select “Video”, press “Enter”
- ⑤ Press “UP” “DOWN” button to select “Source”, press “Enter”
- ⑥ Press “UP” “DOWN” button to select “Source”, press “Enter”
- ⑦ Press “UP” “DOWN” button to select “Input 1~8”, press “Enter”, switch done
- ⑧ Press “MENU” button back to previous option, Press “UP” “DOWN” button to select “Onoff”
- ⑨ Press “Enter”
- ⑩ Press “UP” “DOWN” button to select “Onoff”, output video on/off done. (This function is on by default)

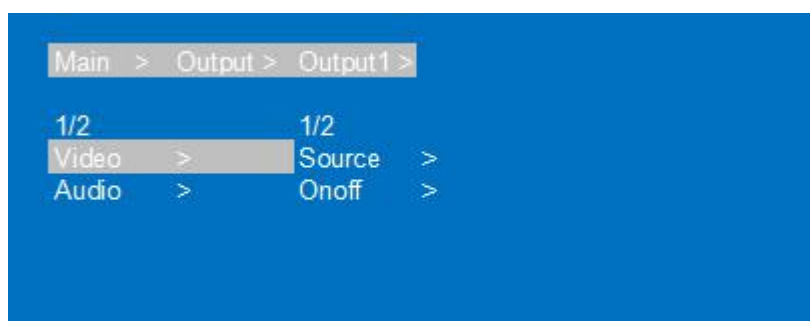

Video Switch interface(picture-6)

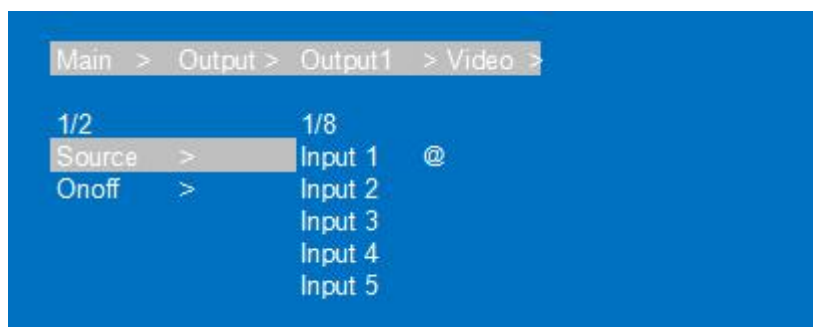

Input port select interface(picture-7)

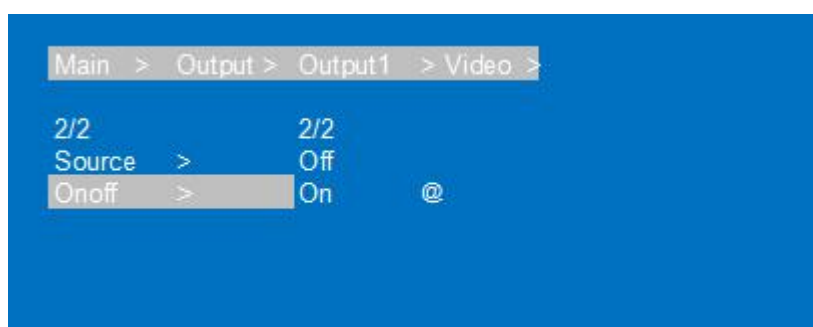

On/off select interface(picture-8)

### 7.3.3 Output Audio on/off control

On/off output audio, include HDMI, Analog, SPDIF, ARC; ARC function is off by default.

Operation instructions: (turn off other audio is same)

- ① Select "Output" and press "ENTER"
- ② Press "UP" "DOWN" button to select "Output1~8 or All(meas all outputs)". The bottom color of the selected output port becomes white.
- ③ Press "Enter"
- ④ Press "UP" "DOWN" button to select "Audio", Press "ENTER"
- ⑤ Press "UP" "DOWN" button to select the mode: HDMI; Analog; SPDIF; ARC, press "ENTER"
- ⑥ Press "UP" "DOWN" button to select "On/Off", output audio on/off done



Audio control interface(picture-9)



Output audio on/off interface(picture-10)

**7.3.4 Input signal control**

Input signal control interface has nine sub-menus:Input1~8 and All(means all inputs), The third level sub-menu includes Video, Audio, and EDID settings.

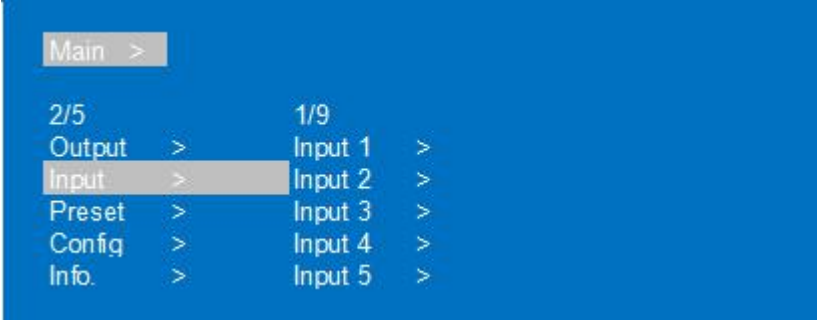

Input option interface(picture-11)

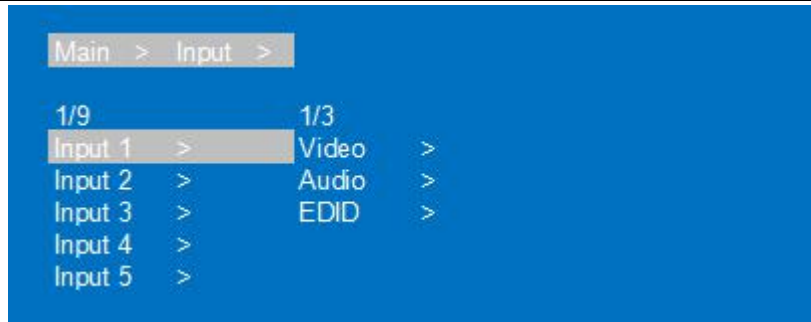

Input mode interface(picture-12)

### 1)On/off input video

#### Turn on/off input video settings

Operation instructions:

- ①Select“Input”, Press“ENTER”
- ②Press “UP” “DOWN” button to select“Input1~8 or All”, Press“ENTER”
- ③Press “UP” “DOWN” button to select“Video”, Press“ENTER”
- ④Select“Onoff”, Press“ENTER”
- ⑤Press “UP” “DOWN” button to select“On/Off”, On/off input video done



Input video control interface(picture-13)

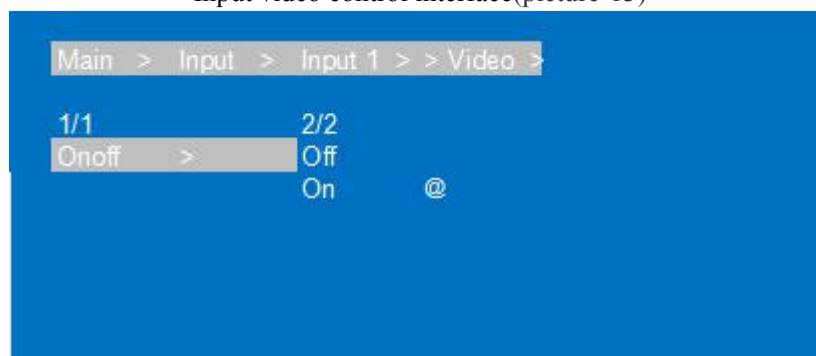

On/off input video interface(picture-14)

**2) On/off input audio and choose audio source**

Choose HDMI input audio or Analog audio embedded and On/off input audio

Operation instructions:

- ① Select "Input", Press "ENTER"
- ② Press "UP" "DOWN" button to select "Input1~8 or All", Press "ENTER"
- ③ Press "UP" "DOWN" button to select "Audio", Press "ENTER"
- ④ Press "UP" "DOWN" button to select "Source", Press "ENTER"
- ⑤ Press "UP" "DOWN" button to select "HDMI/ENC", Press "ENTER", The selected off/on show @
- ⑥ Press "MENU", then press "UP" "DOWN" button to select "Onoff", Press "ENTER"
- ⑦ Press "UP" "DOWN" button to select "On/Off", input audio on/off done.

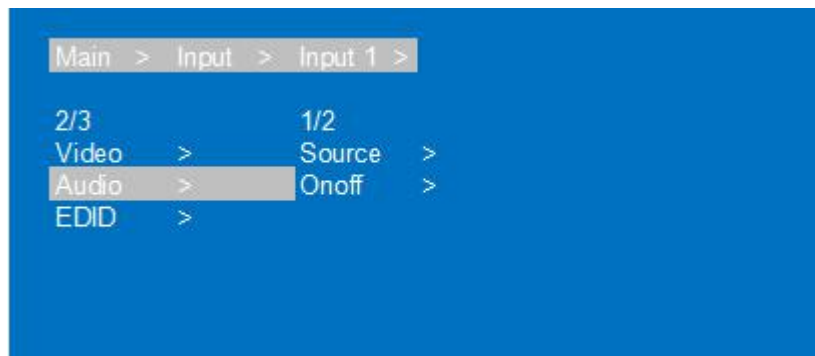

Input audio settings interface (picture-15)

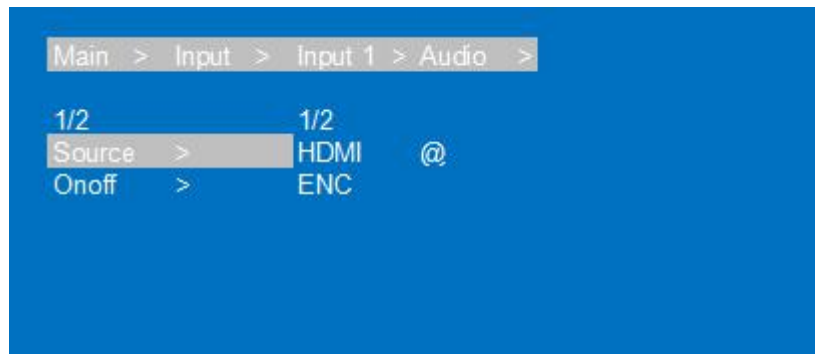

Input audio source choose interface (picture-16)

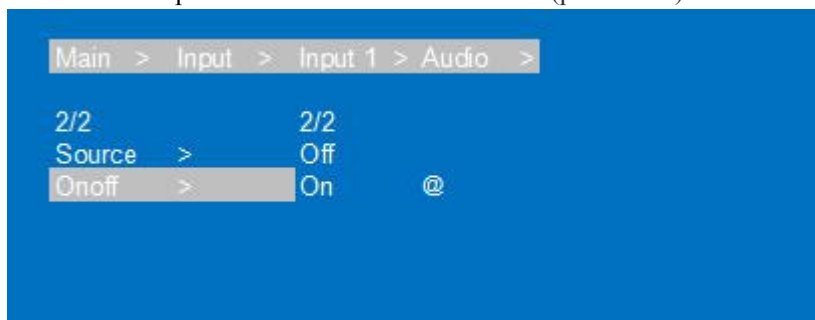

On/off input audio source interface (picture-17)

### 7.3.5 EDID Settings

EDID Mode can set each input's EDID, Include: Default EDID; User EDID; Copy EDID;  
 1-4 are Default EDID, 5-8 are User EDID, 9-16 are Copy output 1-8 EDID, 17 is temporary EDID.

Operation instructions:

- ①Select“Input”, Press“ENTER”
- ②Press “UP” “DOWN” button to select“Input1~8 or All”, Press“ENTER”
- ③Press “UP” “DOWN” button to select“EDID”, Press“ENTER”
- ④Press “UP” “DOWN” button to select EDID“Default1”, Press“ENTER”, setup complete
- ⑤The selected EDID will show EDID details(name, Max resolution, audio format, sound track)

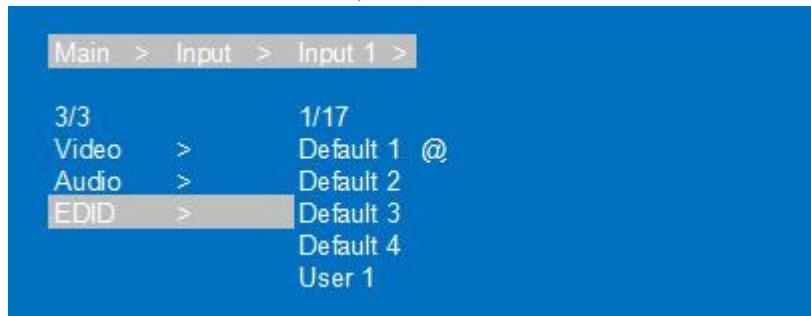

EDID settings interface(picture-18)



EDID information interface(picture-19)

## 7.4 Preset scene settings

Preset can save video, audio, EDID, system settings, support 8 differences presets, It can be changed and called by web page, command and panel buttons. The default preset is same as the factory setting PTP.



Preset option interface(picture-20)

Operation instructions:

- ① Select "Preset", Press "ENTER", then enter preset scene interface;
- ② Save preset: Select "Save" on preset interface, then select one of "Preset1~8"; Press "ENTER", save current scene.
- ③ Call preset: Select "Call" on preset interface, Select one of the saved preset1-8 presets; Press "ENTER", Call the preset scene saved previously.
- ④ Clear preset: Select "Clear" on preset interface, Select one of the saved preset1-8 presets; Press "ENTER", this preset will return default.

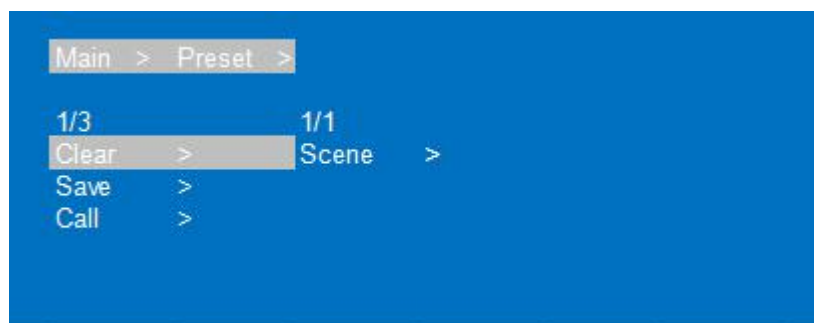

Scene preset interface(picture-21)

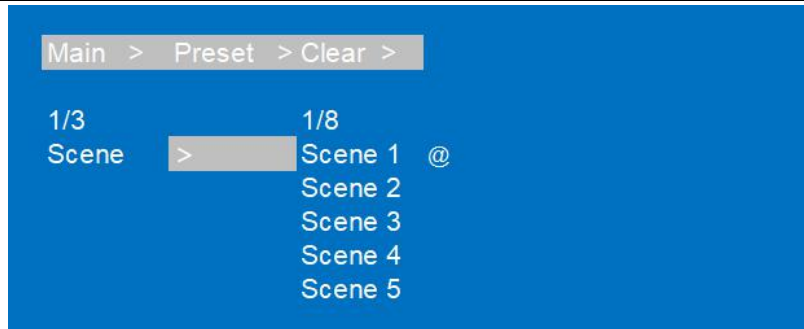

Preset operation interface(picture-22)

## 7.5 System configuration

System configuration can set the device's network parameter, RS-232 baud rate, LCD screen, Menu, User EDID , system parameter.

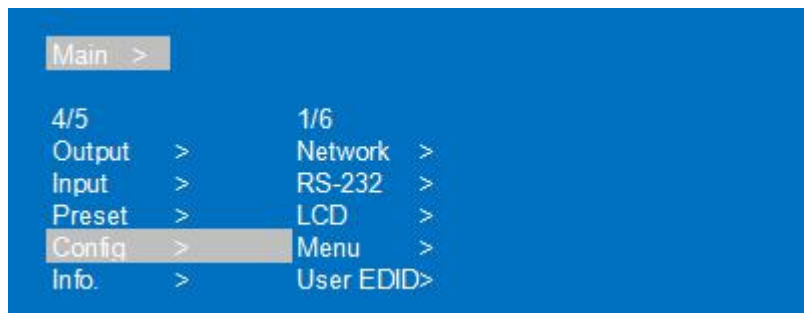

System configuration interface(picture-23)

### Network parameter settings

Set DHCP/IP/MASK/GW/Port/DNS/MAC

- 1 ) DHCP: Default Off(Static), After turn on(Dynamic), IP/MASK/GW are unable to set.
- 2 ) IP address: Default 192.168.1.168
- 3 ) MASK address: Default 255.255.255.0
- 4 ) GW: Default 192.168.1.1
- 5 ) PORT: TCP&UDP port, Default TCP 5000, UDP 5001.
- 6 ) DNS: Default 144.144.144.144 ( unalterable )

Operation instructions:



- ① Select "Config", Press "ENTER"
- ② Press "UP" "DOWN" button to select "Network", Press "ENTER"
- ③ Press "UP" "DOWN" button to select "DHCP", Press "ENTER", you can select "Yes/On" to turn on/off DHCP
- ④ Press "MENU", Select "IP/MASK/GW/Port/DNS/MAC", Press "ENTER"
- ⑤ Such as change IP address: After select IP, enter and select Part 1~4, then Set IP address parameters for each part; Press "Enter" again, LCD'll show the current network parameters. (Do the same for other parameters)



Network parameter settings interface(picture-24)

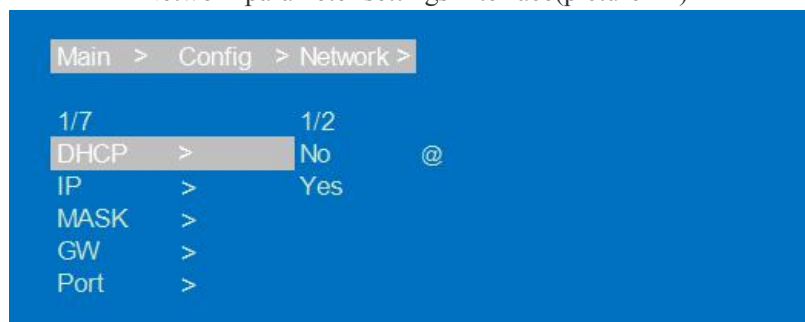

DHCP settings interface(picture-25)

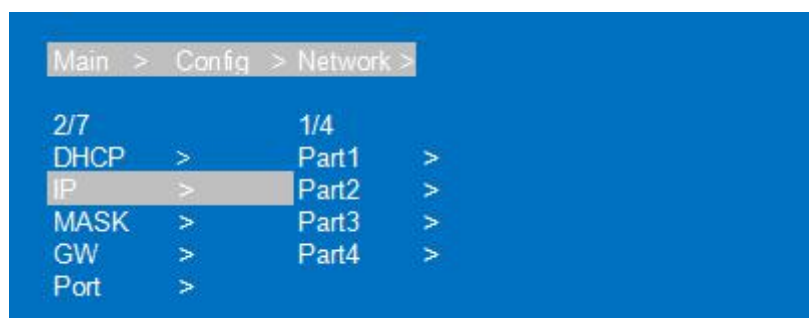

IP settings interface(picture-26)

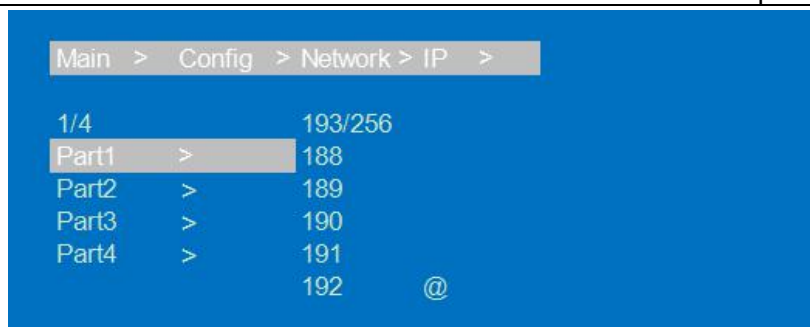

IP parameter set interface(picture-27)

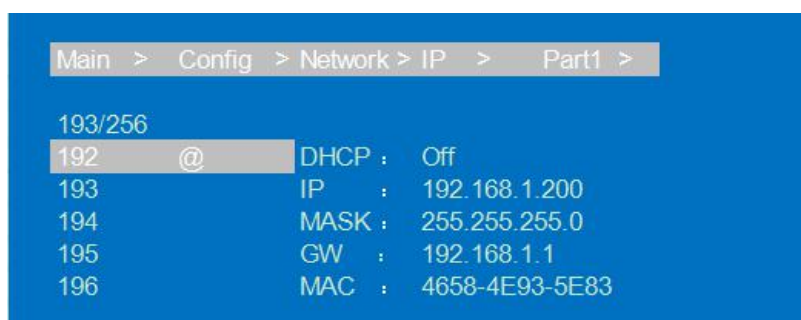

Network parameter display interface(picture-28)

### 7.5.1 RS232 parameter settings

It can change device's baud rate, but Data/Stop/Parity are used for checking and cannot be set

- 1 ) Baud: device's baud rate provide 6 choices, 115200, 57600, 38400, 19200, 9600, 4800. The device is 115200 by default.
- 2 ) Data/Stop/Parity: is used only for view and cannot be changed, Unless use the highest account.
- 3 ) The underscore show that this parameter cannot be set.

Operation instructions:

- ① Select "Config", Press "ENTER"
- ② Press "UP" "DOWN" button to select "RS-232", Press "ENTER"
- ③ Press "UP" "DOWN" button to select "Baud", Press "ENTER"
- ④ Press "UP" "DOWN" button to select Baud rate you need, Press "ENTER", Baud rate set done.



RS232 control interface(picture-29)

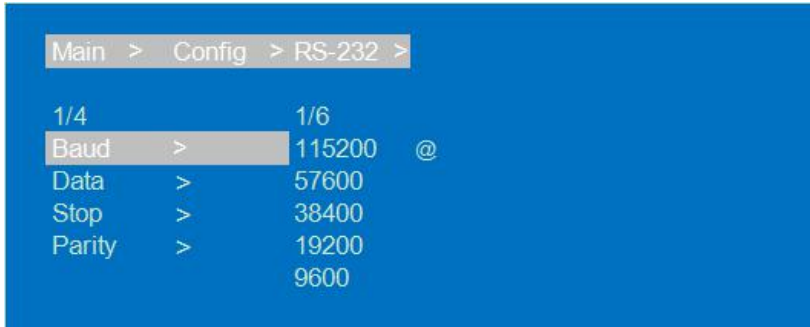

Baud rate set interface(picture-30)



Data display interface(picture-31)

**7.5.2 LCD screen settings**

You can set LCD screen's bright and Screen rest time; Bright is 8 by default, Screen rest time is 30S by default.

Operation instructions:

- ① Select "Config", Press "ENTER"
- ② Press "UP" "DOWN" button to select "LCD", Press "ENTER"
- ③ Press "UP" "DOWN" button to select "Bright", Press "ENTER"
- ④ Press "UP" "DOWN" button to select LCD brightness level, The higher the brightness level, the greater the brightness, otherwise the lower the brightness.
- ⑤ Press "MENU", then press "UP" "DOWN" button to select "Time", Press "ENTER"
- ⑥ Press "UP" "DOWN" button to select screen rest time.

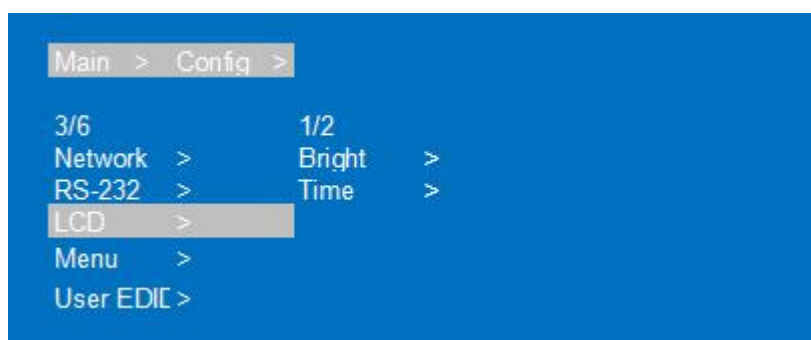

LCD settings interface(picture-32)

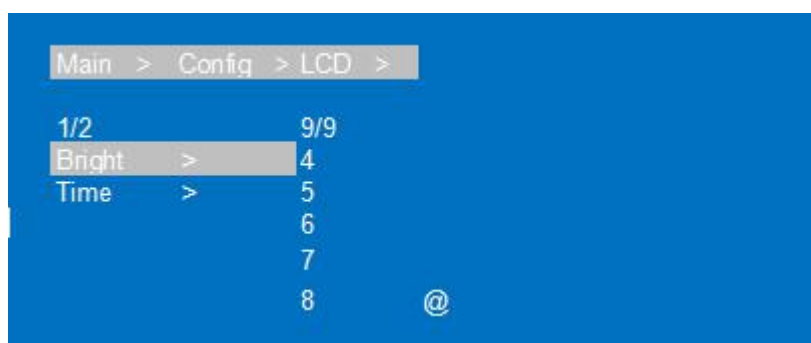

LCD brightness settings interface(picture-33)

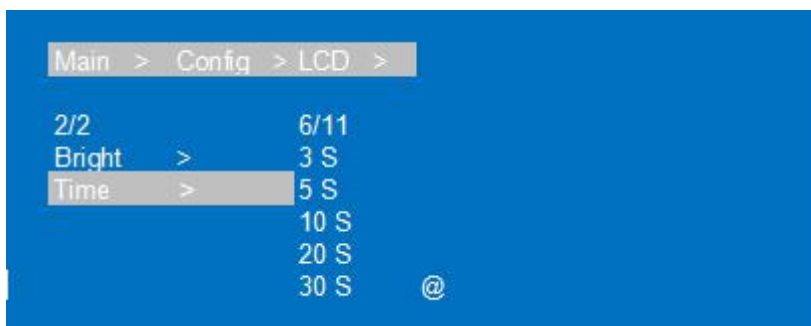

Screen rest time settings interface(picture-34)

### 7.5.3 Menu settings

You can set menu time, Select-run, LV-Read.

- 1 ) Time: No next operation within 30s and return to the channel interface.
- 2 ) Select-run: The default is Disable, Press the button to switch parameters to complete the setting. No need press “Enter”.
- 3 ) LV-Read: The default level is 1. It's not possible to switch level directly, Unless you get client access and then switch by command. (Note that a low level can't set a high level)

Operation instructions :

- ①Select“Config”, Press“ENTER”
- ②Press “UP” “DOWN” button to select“Menu”, Press“ENTER”
- ③Press “UP” “DOWN” button to select“Time”, Press“ENTER”
- ④Press “UP” “DOWN” button to select the time you need.
- ⑤Press “MENU”, Press “UP” ”DOWN” button to select“Select-run”, Press“ENTER”
- ⑥Press “UP” “DOWN” button to select“Disable/Enable”, settings done



Menu settings interface(picture-35)

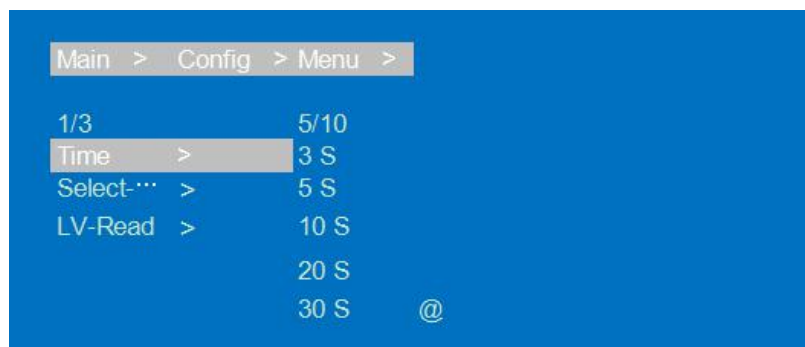

Exit menu Time settings interface(picture-36)

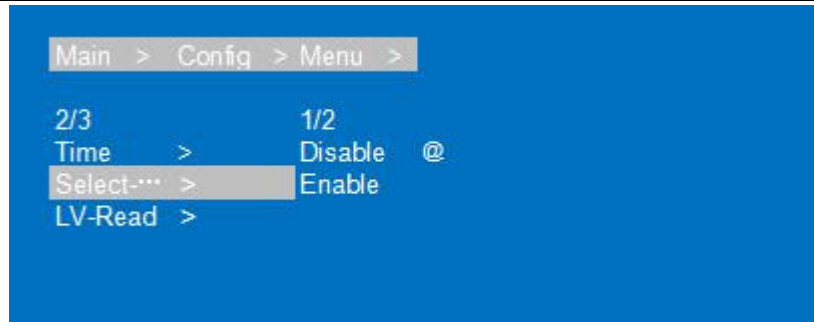

Select-run settings interface(picture-37)

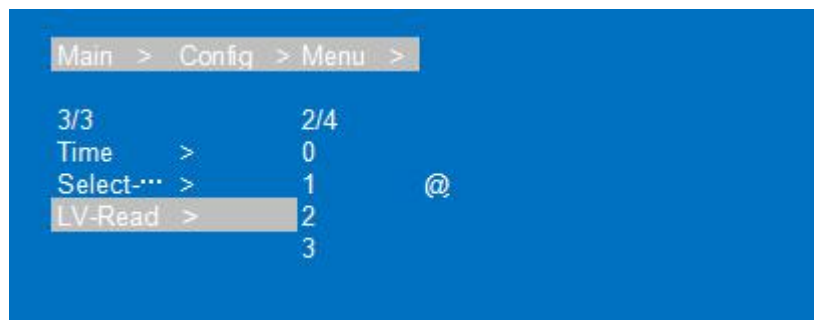

LV-Read settings interface(picture-38)

### 7.5.4 User EDID settings

You can save default EDID, output EDID and temporary EDID to the User EDID.

Operation instructions:

- ① Select "Config", Press "ENTER"
- ② Press "UP" "DOWN" button to select "User EDID", Press "ENTER"
- ③ Press "UP" "DOWN" button to select "User1~4 or ALL", Press "ENTER"
- ④ Press "UP" "DOWN" button to select default EDID, output EDID or temporary EDID to save User EDID, while you can check EDID information.

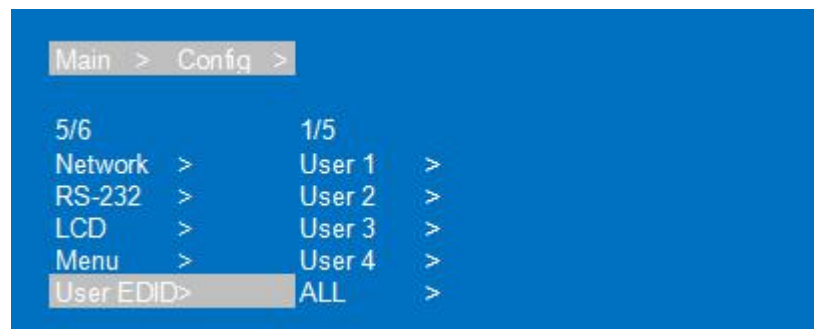

User EDID settings interface(picture-39)

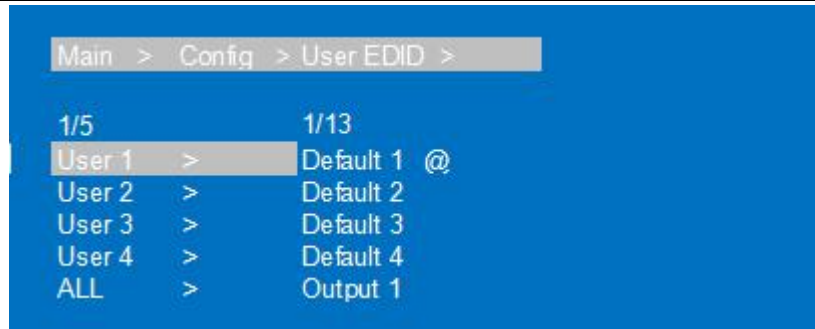

User EDID choose interface(picture-40)

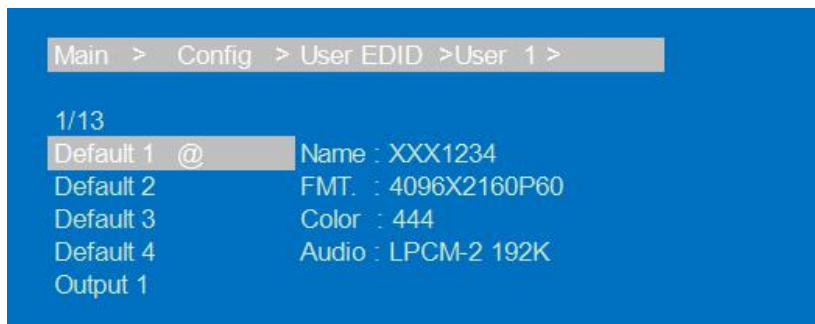

EDID information display interface(picture-41)

### 7.5.5 System settings

You can set device's Reboot, Timing switch, Factory data reset.

1) Reboot: Restart device

Operation instructions:

- ① Select "Config", Press "ENTER"
- ② Press "UP" "DOWN" button to select "System", Press "ENTER"
- ③ Press "UP" "DOWN" button to select "Reboot"+Press "ENTER"
- ④ Press "UP" "DOWN" button to select "Yes"+ Press "ENTER", Device Reboot done.



System settings interface(picture-42)

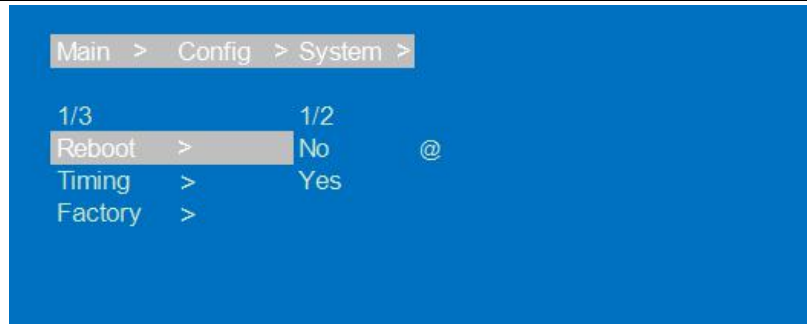

Device reboot interface(picture-43)

2) Timing switch settings: The default is Endless, no timing Settings; The timing units are S/M/H/D, Second/minute/hour/day

Operation instructions:

- ①Select“Config”, Press“ENTER”
- ②Press “UP” “DOWN” button to select“System”, Press“ENTER
- ③Press “UP” “DOWN” button to select“Timing”+ Press“ENTER
- ④Press “UP” “DOWN” button to select“Off/On”, Press“ENTER
- ⑤Press “UP” “DOWN” button to select time you need

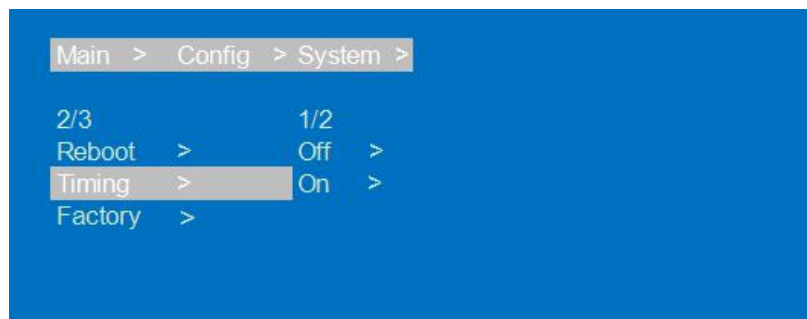

Timing switch interface(picture-44)

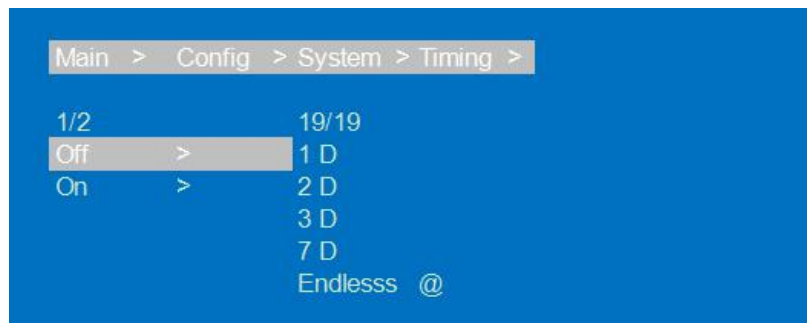

Timing switch time interface(picture-45)

3) Factory data reset: Device function initialization Settings,



General will restore video/audio/EDID/baud to default.

User will restore all settings to default except account.

Operation instructions:

- ① Select "Config", Press "ENTER"
- ② Press "UP" "DOWN" button to select "System", Press "ENTER"
- ③ Press "UP" "DOWN" button to select "General" + Press "ENTER"
- ④ Press "UP" "DOWN" button to select "Yes", Device factory data reset done.

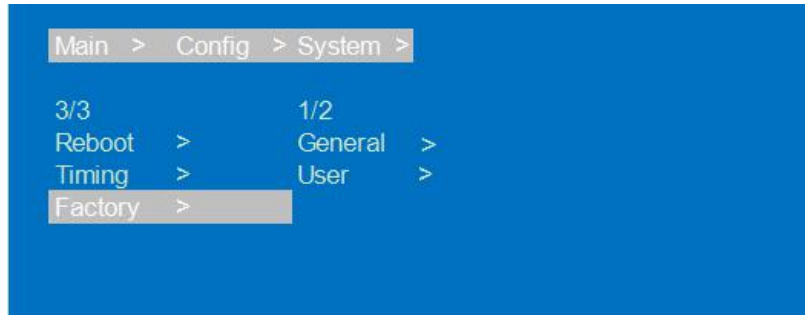

Factory data reset interface(picture-46)

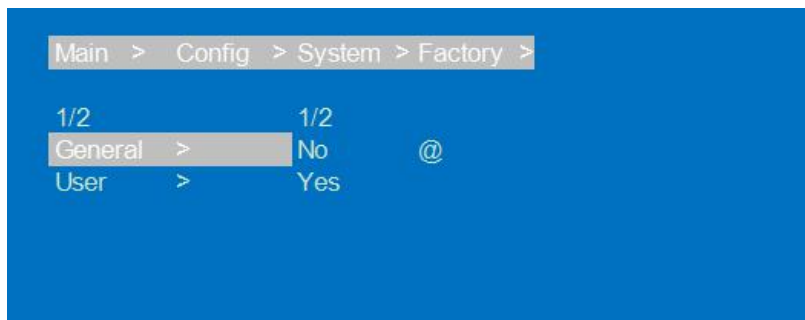

General factory data reset interface(picture-46)



Factory data reset range interface(picture-47)

## 7.6 Device information query

Device information: input information, output information, system information

1 ) input information: Input connection status, Input resolution, Color gamut color depth, audio format and input HDCP version.

2 ) output information: output connection status, output resolution, Color gamut color depth, audio format

Operation instructions:

①Select“INFO”, Press“ENTER”

②Press “UP” “DOWN” button to select“Input/Output”, Press“ENTER”

③Press “UP” “DOWN” button to select input/output port, then see input/output information.

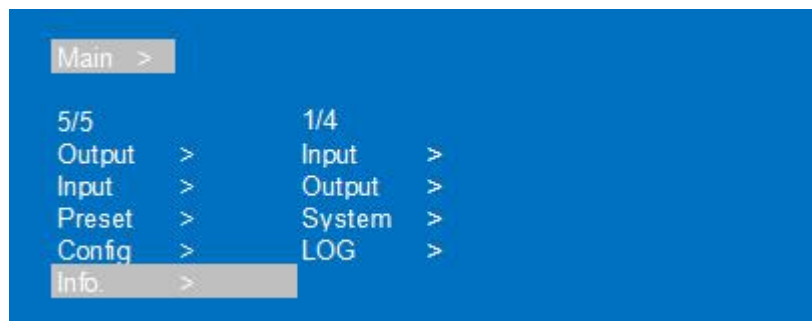

Device information interface(picture-48)

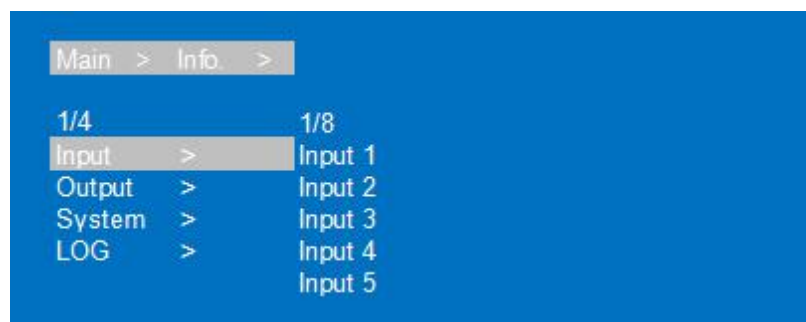

Input port choose interface(picture-49)

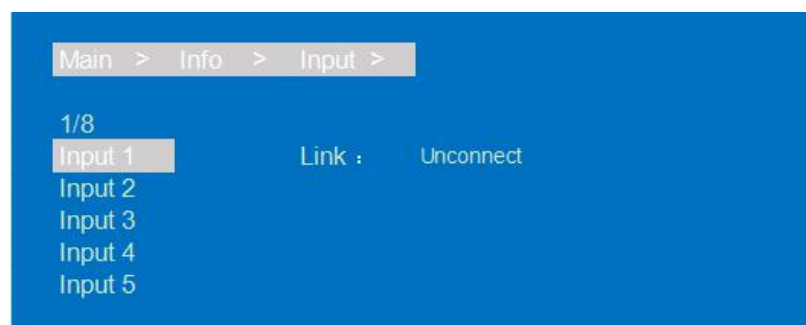

Input information display interface(picture-50)

3) System interface: is used for checking device system information(Manufacturer/Device ID/device type), Version(MCU/web page) and Network parameter(IP/GW, Mask)

Operation instruction:

- ① Select "INFO", Press "ENTER"
- ② Press "UP" "DOWN" button to select "Device", Press "ENTER"
- ③ Press "UP" "DOWN" button to select "Device/Versions/Network", then you can check information.



Input information display(picture-51)

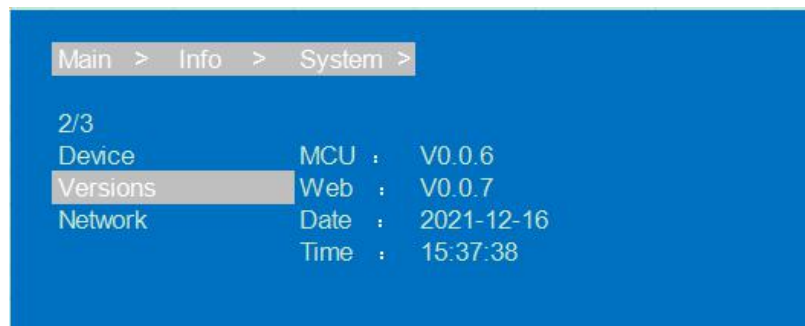

Input information display(picture-52)

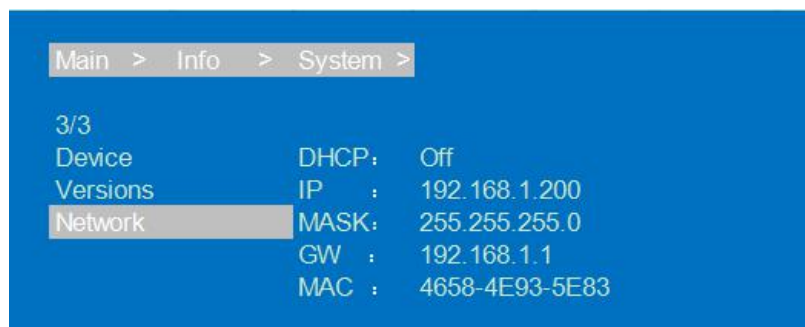

Input information display(picture-53)

4) LOG: it used for checking device information: running time, startup times, operation times, runs errors times.

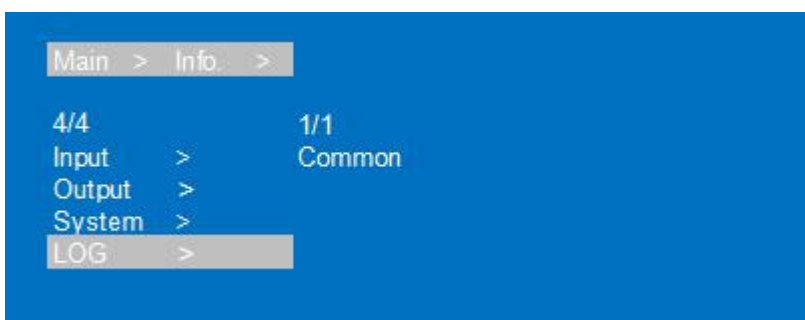

Input information display(picture-54)

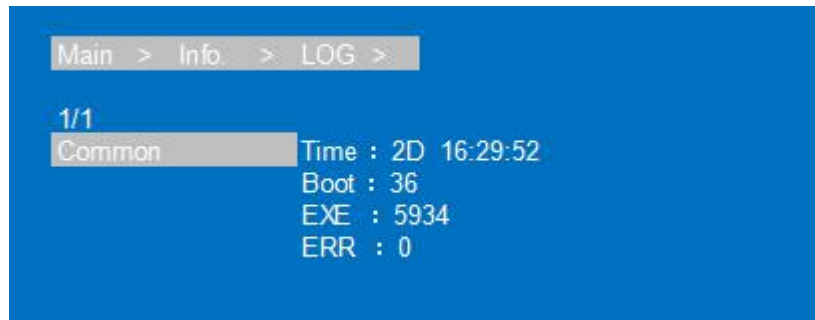

Input information display(picture-55)

## 7.7 Remote Control Description

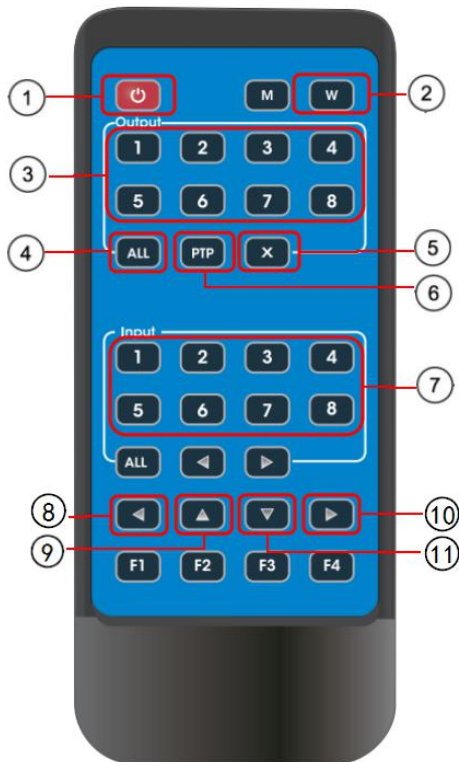

- ① Standby mode
- ② Lock or Unlock panel button
- ③ Choose output from 1~8
- ④ Choose all the outputs
- ⑤ X: Turn on/off output port which you select
- ⑥ PTP button: Mirror all inputs and outputs (Ex. Input 1 to output 1, input 2 to output 2, etc)
- ⑦ Choose Input from 1~8
- ⑧ Menu (back to previous option) button
- ⑨ UP button
- ⑩ Enter button
- ⑪ DOWN button

## 8. AUDIO INTRODUCTIONS

### 8.1 HDMI audio

HDMI audio support PCM2.0-7.1/32-192KHZ/16-24bit, Dolby/DTS/Dolby Atmos/DTS-HD, and maximum 7.1 channels, but the supported audio format, channel, and sampling rate depend on the EDID.

### 8.2 Audio extraction

Analog audio only support PCM2.0, 32-192KHZ, 16-24BIT; S/PDIF audio output support PCM/Dolby/DTS, 32-96KHZ, 16-24bit, maximum 5.1 channels

#### 8.2.1 Analog audio extraction

- ①When the 8×8 matrix is selected for one to one output, the analog audio output can only output the audio of the port.
- ②When the HDMI output port is muted, coaxial and analog audio output will not be affected
- ③Analog audio only support PCM2.0, otherwise Auto-Mute
- ④Analog audio left and right channels cannot be reversed output
- ⑤Analog audio will Auto-Mute when digital audio input.

#### 8.2.2 SPDIF audio extraction

- ①When the 8×8 matrix is selected for one to one output, the coaxial audio output can only output the audio of the port.
- ②When the HDMI output port is muted, coaxial and analog audio output will not be affected.

### 8.3 Audio embedded

8×Analog audio support embedded, LINE IN1~8 correspond HDMI IN1~8 ; Analog audio only support PCM2.0 format audio. After the audio embedding function is turned on, embedded audio can be output through HDMI/analog/SPDIF ports.

### 8.4 ARC audio

Supports output 1~8 audio transmission back to SPDIF 1~8 and PCM/DTS/DOBLY 5.1 audio format

Operation instruction:

1. HDMI source and TV both need support CEC, TV also need support ARC. You need to turn on the TV and HDMI source CEC and ARC functions.
2. HDMI source connect TV
3. TV's HDMI ARC port connect output 1~8
4. Use a coaxial cable to connect the power amplifier to SPDIF port ( correspond HDMI ARC output )
5. Turn on device's ARC function by panel button/command/WEB, done

## 9. EDID MANAGEMENT

The device include 4 EDID modes: Default EDID, User EDID, Output EDID, Temp1, control EDID by WEB and RS232. Factory Default: Default1 4K60 444 2CH

The instructions are follow:

1. Send instruction: #edid\_d in%8,d source=%d switch EDID, “in%8,d” parameter need to input 255 or 0~7 (255 means all input), source=%d=0~24(Correspond the table below)

| EDID MODE    | EDID Index | EDID   |
|--------------|------------|--|
| Default EDID | 0          | 4096x2160@60-444 HLG 2CH(default)  |
|              | 1          | 4096x2160@60-420 HLG 2CH   |
|              | 2          | 4096x2160@30-444 HLG 2CH   |
|              | 3          | 1920x1080P@120-444 HLG 2CH   |
| User EDID    | 4-7        | User EDID is set by user, with power-off memory function, new EDID will auto-cover old EDID. |
| Output EDID  | 8-15       | Copy output 1-8 ports' EDID with storage function. without power-off memory                  |
| Temp1        | 24         | Temporary EDID   |

Note The above EDID supports 4K Downscaler 1080P

## 10. RS232 CONTROL

Control software operation:

The serial control software is illustrated with SSCOM32 as an example.

Basic Settings:



Double-click the software in the installation package to run specifically (as shown in figure 1 below) and install the RS232 software on the computer.

Enter the main interface of the software, as shown in the figure below.

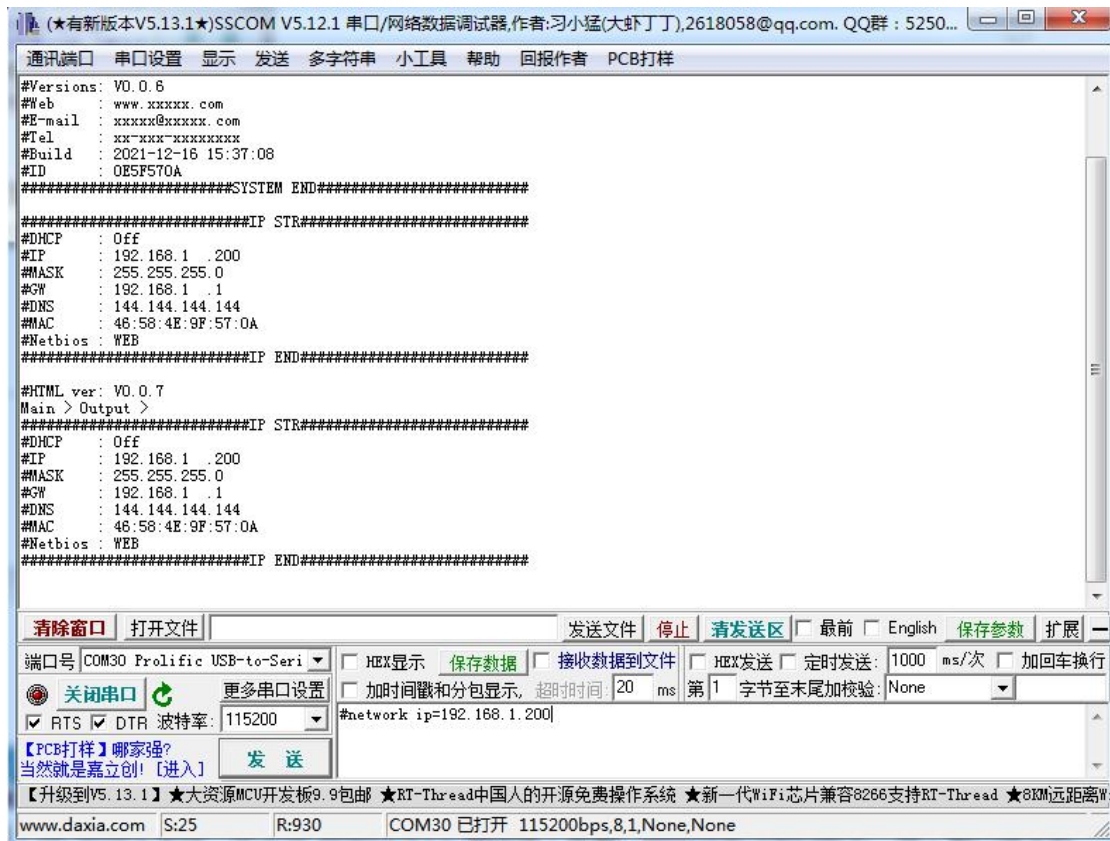

RS232 control interface(picture-56)



In the parameter configuration area, select the serial port number that the serial line connects to the PC

Baud rate: 115200 (default)

Data location: 8

Stop bit: 1

Check bit: no

Enter Port Command in Send options.

Instructions:

All commands start from “#”, command head “%c”: “d” parameters.

The “\_” in the commands cannot omit. Parameter: %d: 0 means ALL.

Command head & Parameter1 &Parameter2... need to add one “SPACE”.

**The following table is only an example. Please refer to the list of instructions.**

| Type         | format    | data  | Rule                                   |
|--------------|-----------|---|--|
| instructions | #video_%c | d:data  |  |
| Target 1     | in%8,d    | 0~7:assign port<br>255:all port                   | parameter 2 attributes are available   |
| Target 2     | out%8,d   | 0~7:assign port<br>255:all port                   | All parameter attributes are available |
| Parameter 1  | source=%d | 0~7: input channel                                |  |
| Parameter 2  | onoff=%d  | 0:image output turn off<br>1:image output turn on |  |

Please refer to the " Command list" for details

Example: ALL output turn off.

Operation format: #video\_d out255 onoff=0

## 11. WEB CONTROL

### 11.1 Address Information

|                 |  |
|-----------------|--|
| Static IP Add : | 192.168.1.168                                |
| Sub-Mask :      | 255.255.255.0                                |
| Gateway :       | 192.168.1.1                                  |
| Dynamic IP      | OFF  |
| TCP/UDP Port    | TCP 5000; UDP 5001                           |
| MAC             | 4657-4E9F-570A<br>(Changes with GUI modules) |

### 11.2 Change the IP address of your PC.

- 1). Connect the HDMI Matrix and PC to the LAN.
- 2). Configure your PC as follows:
  - ① Click **Start > Control Panel > Network and Sharing Center**.
  - ② Click **Change Adapter Settings**.
  - ③ Highlight the network adapter you want to use to connect to the device and click **Change settings of this connection**.
- 3). Connect to the device and click change settings of this connection:
- 4). Highlight **Internet Protocol Version 4 (TCP/IPv4)** by clicking on the item.
- 5). Click **Properties**.

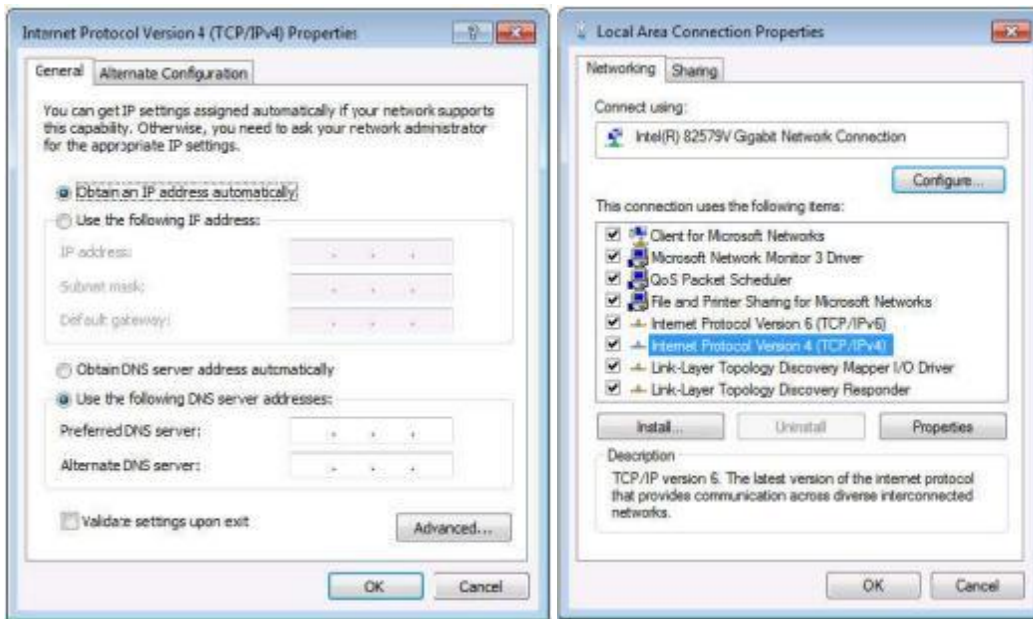

Change IP address interface (picture-57)

6). Select **Use the following IP Address** for static IP addressing and fill in the details.

For TCP/IPv4 you can use any IP address in the range 192.168.1.2 to 192.168.1.254 (excluding 192.168.1.168).

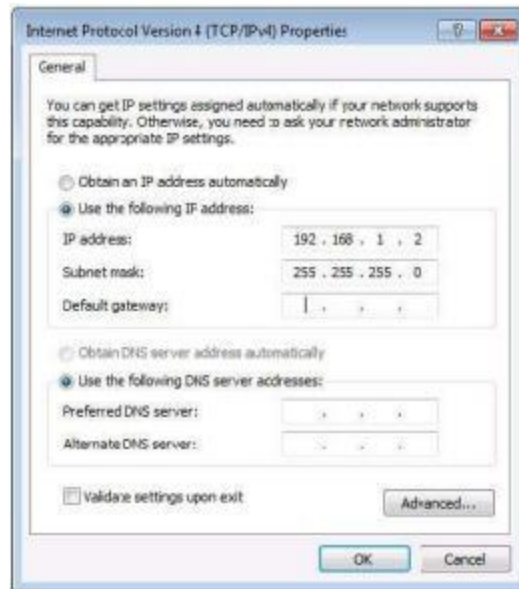

Change IP address interface (picture-58)

7). Click **OK**.

8). Click **Close**.

### Enter Web and Control

Enter the default IP address of the matrix: 192.168.1.168

Account: admin

Password: 123456

## 12. STATUS INTERFACE

Status interface include 3 parts: input information, output information and device version information

1. Input info: Displays the status and information of the current device input port, Includes the connection status, input resolution, gamut color depth, HDCP version information and input audio format of each input port.

2. Output EDID info: Displays the status and information about the output port, Includes the connection status, output resolution and color gamut, output audio format, EDID manufacturer of each output port.

3. Dvce info: Displays the current name of the device, MCU and HTML of version number(Same as on the screen)

4. “√”show that open or connect normally, “×”show that close or not connected.

The screenshot displays the 'Status' interface with a sidebar menu on the left containing: Status, Input, Output, Matrix, Preset, CEC, and System. The main content area is divided into three sections:

**Input Info**

|     | Connected | Resolution    | Color         | Audio           | HDCP |
|-----|-----------|---------------|---------------|-----------------|------|
| In1 | √         | 1920×1080P 60 | RGB 24bit HDR | PCM-2 48K 24bit | None |
| In2 | ×         | ×             | ×             | ×               | ×    |
| In3 | ×         | ×             | ×             | ×               | ×    |
| In4 | ×         | ×             | ×             | ×               | ×    |
| In5 | ×         | ×             | ×             | ×               | ×    |
| In6 | ×         | ×             | ×             | ×               | ×    |
| In7 | ×         | ×             | ×             | ×               | ×    |
| In8 | ×         | ×             | ×             | ×               | ×    |

**Output EDID Info**

|      | Connected | Resolution    | Color   | Audio      | Product |
|------|-----------|---------------|---------|------------|---------|
| Out1 | √         | 4096×2160P 60 | 444 HLG | LPCM2 192K | XXX1234 |
| Out2 | ×         | ×             | ×       | ×          | ×       |
| Out3 | ×         | ×             | ×       | ×          | ×       |
| Out4 | ×         | ×             | ×       | ×          | ×       |
| Out5 | ×         | ×             | ×       | ×          | ×       |
| Out6 | ×         | ×             | ×       | ×          | ×       |
| Out7 | ×         | ×             | ×       | ×          | ×       |
| Out8 | ×         | ×             | ×       | ×          | ×       |

**Device Info**

|                |        |
|----------------|--------|
| MCU Version :  | V0.0.6 |
| HTML Version : | V0.0.7 |

Status interface (picture-59)

## 12.1 Input interface

Interface introduction: This page is mainly used for renaming input ports, switching video signals (opened by default), switching audio input, selecting EDID, and switching audio source signals.

1. Rename: Modify the current name of input port, support 1~15 characters(numbers, letters and underscores) which is synchronized with the screen.
2. Video: Switch input video, Once the input video is off, the audio extraction output is muted.
3. Audio: Switch audio of audio source (include HDMI and embedded audio), The default is on.
4. Audio Source: Switch audio source, HDMI: select input source audio, ENC: select embedded audio input.
5. Switch EDID: Set default, copy, user EDID, and show EDID information(HDR, audio channel, resolution, colour gamut)
6. User EDID: Save default/copy EDID to User EDID, and upgrade the BIN file to the User EDID.
7. All: select all input ports to realize fast switch .



Input interface (picture-60)

Operation instructions:

- 1. Rename: Double click the left mouse button to enter the name editing to customize the name, name modify done.
- 2. Video/Audio: Click the two-way button to complete the switch setting of input video and audio; Green means on and gray means off.
- 3. Audio source: Use the mouse to click the white combobox to switch the corresponding input audio source.
- 4. Copy EDID from: Use the mouse to click the white combobox to complete the corresponding EDID switch. The combobox'll show the current EDID information.

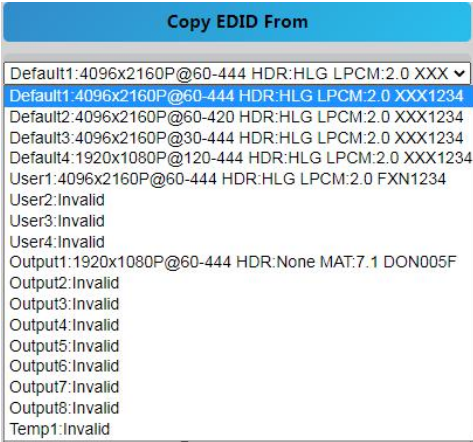

Copy EDID from (picture-61)

5. User EDID selection:

①: Click the white combobox, select EDID, then select user1 ~ 4 in the combobox, and finally click apply, User EDID settings done.

②: Click browse and select the path where the bin file is located, then select user1 ~ 4 in the combobox and finally click Upload. The EDID can be imported into user EDID.

## 12.2 Output interface

Interface introduction: The page used for port renaming, switching output video(on by default), switching audio output(HDMI/Analog/SPDIF), ARC function(off by default).

1. Rename: Modify the current name of output port, support 1~15 characters(numbers, letters and underscores) which is synchronized with the screen.
2. Video: Switch output video, close the output port video does not affect the audio extraction function, the 5V output needs to be turned off at the same time.
3. Audio-HDMI: Switch HDMI output audio, on by default.
4. Audio-Analog: Switch Analog audio extraction output, on by default .
5. Audio-SPDIF: Switch SPDIF audio extraction output, on by default.
6. ARC: Switch ARC audio return output, off by default.



Output interface(picture-62)

Operation instructions:

1. Double click the left mouse button to enter the name editing to customize the name, the output port name modify done.
2. Click the two-way button to complete the switch setting of output video, audio and ARC function; Green means on and gray means off.

### 12.3 Matrix interface

Interface introduction: The page is used for displaying the input source corresponding to the current output port, Switching the input to a output port and output the image; Vertical axis means output port selection, abscissa axis means input port selection, All means select all output

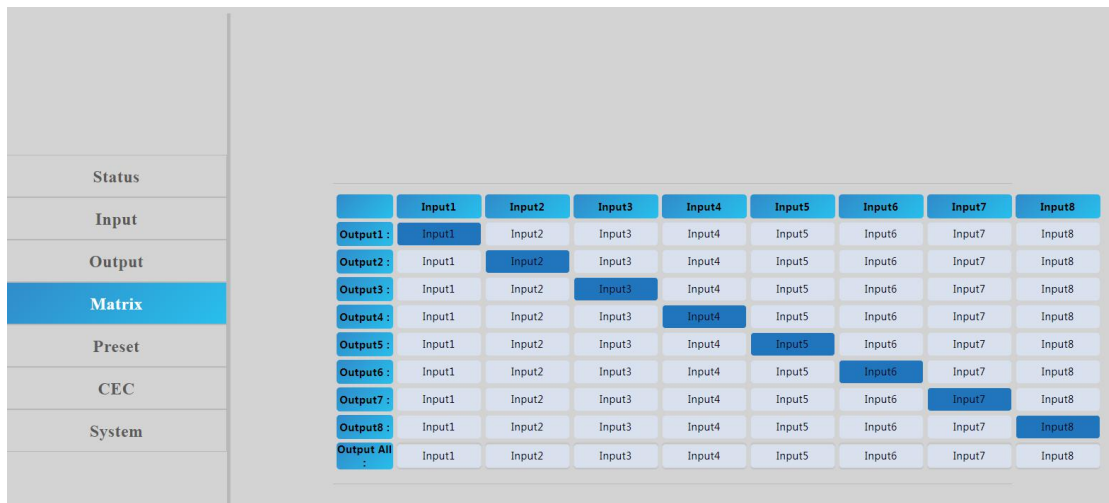

Matrix interface (picture-63)

Operation instructions: Click the input box to switch the corresponding output port, The above picture show the PIP one to one output.

### 12.4 Preset interface

Interface introduction: The page is used for renaming, saving, calling and clearing of preset scene.

1. The device can preset 8 scenes and support scene renaming.
2. Clear means clears the current saved scene.
3. Save means save the current changed scene, the video, audio and system settings can be saved, but network parameter cannot be saved.
4. Call means call the changed scene.



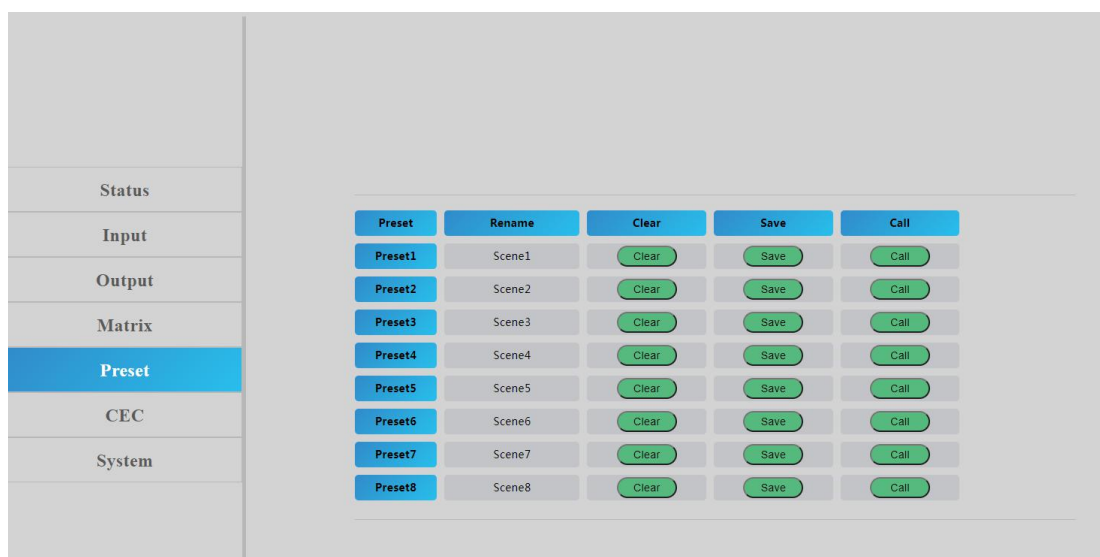

Preset interface (picture-64)

Operation instructions:

1. Double click the left mouse button Preset1, Click enter to the name edit box, custom name done.
2. Click Clear, scene clear done
3. Click Save, save the current scene
4. Click Call, call the saved scene

## 12.5 CEC control interface

Interface introduction: By web page control the switch of input source or output TV and settings of volume increase and decrease, but the prerequisite is input source and output TV support CEC function; Page all English corresponding remote control functions.

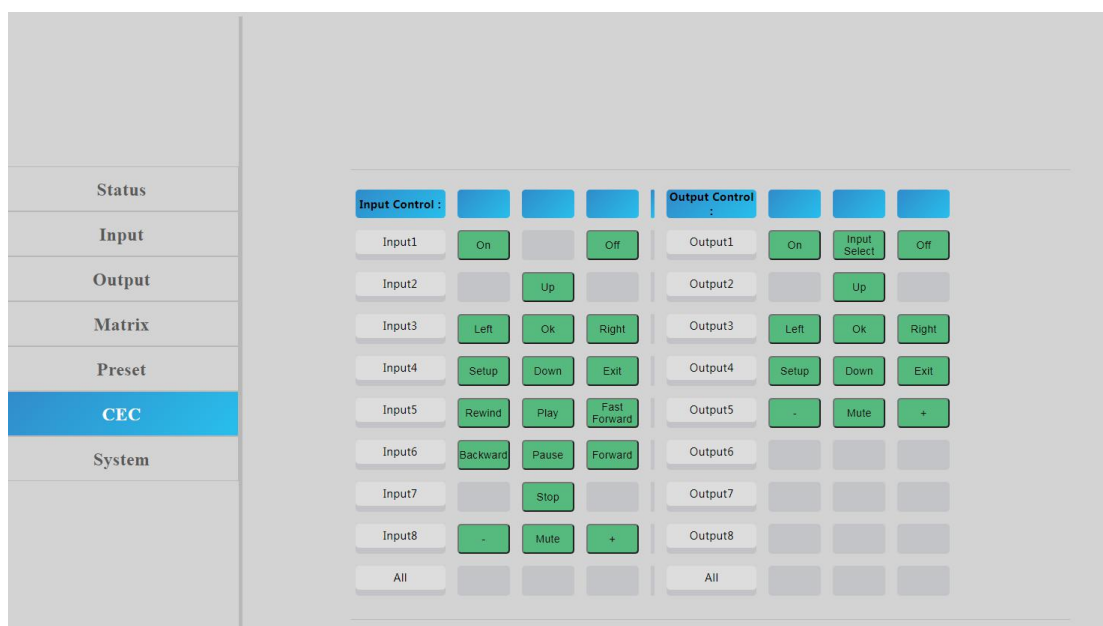

CEC control interface (picture-65)

Operation instructions:

1. Click the selected input or output port
2. Click operation button to complete control
3. Operation instructions:(Signal source and TV must support CEC function and CEC need to be opened)
  - ①Select input, Click left, up, OK, Sony player will react
  - ②Select output, Click on/off, Sony TV will on/off

**CEC function may be not compatible with some signal sources and TVs in the market.**

## 12.6 System interface

Interface introduction: The page can modify and show network parameters and control protocol parameters, modify web login account and password, reboot device, general restore factory, user restore factory.

1. Mac address can only be displayed and cannot be modified.
2. IP address is 192.168.1.168 by default , it can be modified.
  - ①After DHCP is opened, dynamic IP is used, In this case, the IP address cannot be modified and can assign by router.
  - ②After DHCP is off, static IP is used, In this case, the IP address can be modified. After the modification, click Apply.

3. MASK and GW address can be modified, but the prerequisites are same as the IP address.
4. DHCP use two-way button as switch, click directly to open DHCP. Green button means open DHCP, Gray means close DHCP.
5. Account management: Enter your account and password in the white box, Click Apply, It takes effect on next login, support 1~15 characters(numbers, letters and underscores)
6. Click Reboot/Factory General/Factory User, click enter according to the prompt, Device Reboot/restore factory done.

The screenshot displays a web-based system interface with three main sections:

- Network:** Contains fields for Mac Address, IP Address, Net Mask Address, Gate Way Address, DHCP (with a toggle switch currently set to 'Off'), and TCP Port. An 'Apply' button is located at the bottom of this section.
- Account management:** Contains fields for User Name, New Password, and Confirm the Password. An 'Apply' button is located at the bottom of this section.
- Reboot/Factory User:** Contains three buttons: 'Reboot', 'Factory General', and 'Factory User'.

System interface (picture-65)

## 13. FIRMWARE UPGRADE

Operation instructions :

1. Connect PC and Device with RS232, open software UART\_ISP\_V1.6.exe on PC
2. Click“Refresh” refresh the serial port number and select the correct serial port number
3. Baud data is 115200 by default.
4. Input“A1” on the port, Select the path where the program resides to upgrade the MCU.
5. Input “F0”on the port, Select the path where the program resides to upgrade the web page.

Click“Update”, the system start to update until “Succed”is displayed in the information bar, update done

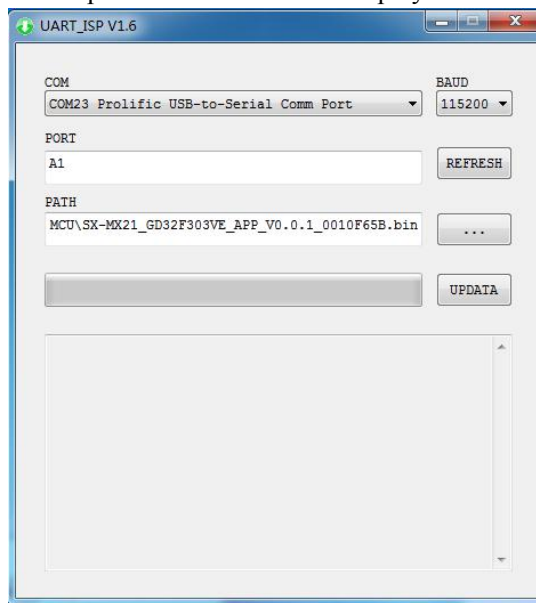

Upgrade interface (picture-66)

# 14. CONNECTION DIAGRAM

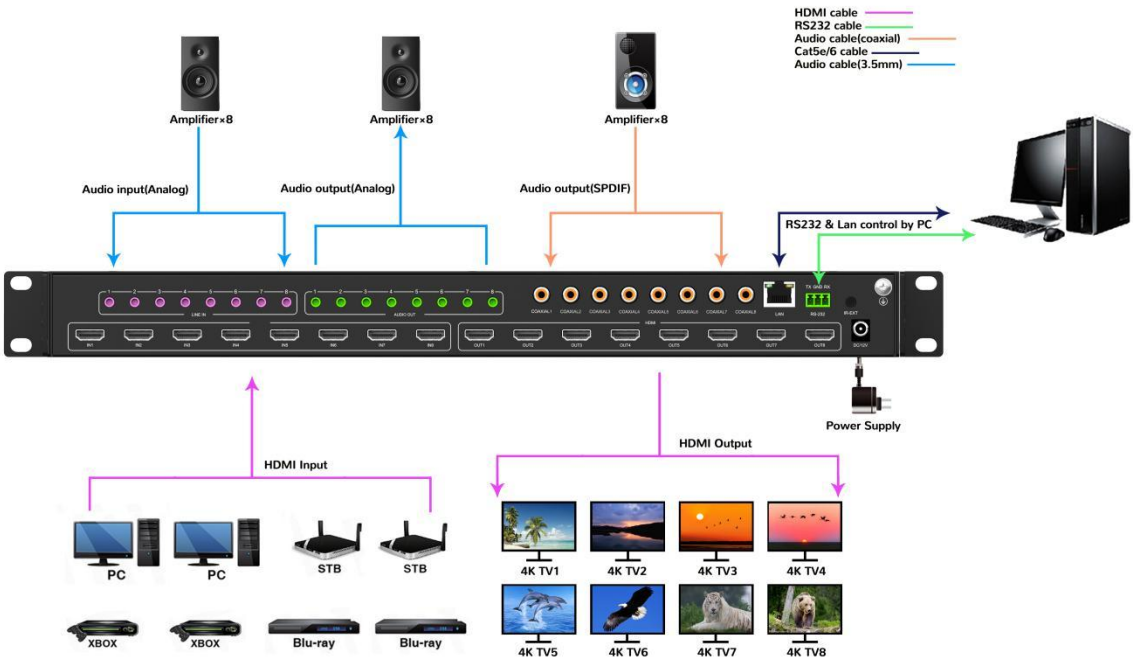

## **MAINTENANCE**

Clean this unit with a soft, dry cloth. Never use alcohol, paint thinner or benzene to clean this unit.

## **PRODUCT SERVICE**

### **(1) Damage requiring service:**

The unit should be serviced by qualified service personnel if:

- The DC power supply cord or AC adaptor has been damaged;
- Objects or liquids have gotten into the unit;
- The unit has been exposed to rain;
- The unit does not operate normally or exhibits a marked change in performance;
- The unit has been dropped or the cabinet damaged.

**(2) Servicing Personal:** Do not attempt to service the unit beyond that described in these operating instructions. Refer all other servicing to authorized service personnel.

**( 3 ) Replacement parts:** Please ensure the defective parts to be replaced by manufacturers or the same specifications as the original parts. Unauthorized substitutes may result in fire, electric shock, or other Hazards.

**(4) Safety check:** After repairs or service, ask the servicer to perform safety checks to confirm that the unit is in proper working condition.

## WARRANTY

### Limited Warranty Limits and Exclusions

- If your product does not work properly because of defective materials or workmanship, our Company (referred to as "the warranter" ) will, for the length of the period indicated as below, **(Parts(2)Year, Labor(90) Days)** which starts with the date of original purchase ("Limited Warranty period"), at its option either(a) repair your product with new or refurbished parts, or (b) replace it with a new of a refurbished product. The decision whether to repair or replace the product will be made by the warranter.
- During the "Labor" Limited Warranty period there will be no charge for labor.
- During the "Parts" warranty period, there will be no charge for parts. You must mail-in your product during the warranty period.(Please prepaid and insured for the unit and then ensure it was packed carefully in the original carton. Besides, detailed complaint description and your contact information should be attached in it. )This Limited Warranty is only valid for the original purchaser and only covers the newly purchased product. A purchase receipt or other proof of original purchase date is required for Limited Warranty service.
- This Limited Warranty ONLY COVERS failures result from defective materials or workmanship, and DOES NOT COVER normal wear and tear or cosmetic damage.
- The Limited Warranty ALSO DOES NOT COVER damages which occurred in shipment, or failures which are caused by products not supplied by warrantor, or failures which result from accidents, misuse, abuse, neglect, mishandling, misapplication, alteration, faulty installation, set-up adjustments, misadjustment of consumer controls, improper maintenance, power line surge, lightning damage, modification, or service by anyone other than a Factory Service center or other Authorized Servicer, or damages that caused by acts of God.
- THERE ARE NO EXPRESS WARRANTIES EXCEPT AS LISTED UNDER "LIMITED WARRANTY COVERAGE". THE WARRANTOR IS NOT LIABLE FOR INCIDENTAL OR CONSEQUENTIAL DAMAGES RESULTING FROM THE USE OF THIS PRODUCT, OR ARISING OUT OF ANY BREACH OF THIS WARRANTY. (for example, it excludes damages for lost time, cost of someone remove or re-install an installed unit that was applicable, round trips, loss of or damage to media or images, data or other recorded content. Please note that the items listed above are not exclusive, but only for illustration )
- THE PURCHASER OR USERS SHOULD TAKE RESBONSIBILITY FOR PARTS AND SERVICE THAT DOES NOT COVERED IN THIS LIMITED WARRANTY .