

---

# CPL03-LB -- LoRaWAN Pulse/Contact Sensor User Manual

last modified by Xiaoling  
on 2023/10/12 15:31

---

# **DIREKTRONIK**

*Dataprodukter utöver det vanliga*

# Table of Contents

1. Introduction .....	5
1.1 What is CPL03-LB LoRaWAN Pulse/Contact Sensor .....	5
1.2 Features .....	6
1.3 Specification .....	7
1.4 Applications .....	7
1.5 Sleep mode and working mode .....	7
1.6 Button & LEDs .....	7
1.7 BLE connection .....	8
1.8 Pin Definitions .....	8
1.9 Mechanical .....	9
2. Configure CPL03-LB to connect to LoRaWAN network .....	10
2.1 How it works .....	10
2.2 Quick guide to connect to LoRaWAN server (OTAA) .....	10
2.3 Uplink Payload .....	15
2.3.1 Device Status, FPORT=5 .....	15
2.3.2 Sensor Configuration, FPORT=4 .....	16
2.3.3 CPL01:Real-Time Open/Close Status, Uplink FPORT=2 .....	18
2.3.4 CPL03:3 pulse mode, Uplink FPORT=6 .....	20
2.3.5 Historical Open/Close Event, FPORT=3 .....	23
2.4 Payload Decoder file .....	25
2.5 Datalog Feature .....	25
2.5.1 Ways to get datalog via LoRaWAN .....	25
2.5.2 Unix TimeStamp .....	26
2.5.3 Set Device Time .....	27
2.5.4 Poll sensor value .....	27
2.6 Frequency Plans .....	28
3. Configure CPL03-LB .....	28
3.1 Configure Methods .....	28
3.2 General Commands .....	28
3.3 Commands special design for CPL03-LB .....	28
3.3.1 Set Transmit Interval Time .....	28
3.3.2 Set Power Output Duration .....	29
3.3.3 Enable / Disable Alarm .....	29
3.3.4 Alarm Base on Timeout .....	29
3.3.5 TTRIG timeout status alarm .....	30
3.3.6 Set trigger mode of PA8 .....	30
3.3.7 Set trigger mode of PA4 .....	31
3.3.8 Set trigger mode of PB15 .....	31
3.3.9 Set the calculate flag .....	31
3.3.10 Set count number .....	31
3.3.11 Clear all counter values .....	32
3.3.12 Count Mod .....	32
3.3.13 Work Mod .....	32
3.3.14 Set Time Sync Mode .....	33
4. Battery & Power Consumption .....	33
5. OTA Firmware update .....	33
6. FAQ .....	34
6.1 AT Commands input doesn't work .....	34
6.2 How to Connect Dry contacts or Wet Contacts .....	34
6.3 What is the maximum total number of pulses for CPL03? What happens after the maximum total number of pulses is reached? .....	34
7. Order Info .....	34
8. Packing Info .....	34

9. Support ..... 35



**Table of Contents:**

- [1. Introduction](#)
  - [1.1 What is CPL03-LB LoRaWAN Pulse/Contact Sensor](#)
  - [1.2 Features](#)
  - [1.3 Specification](#)
  - [1.4 Applications](#)
  - [1.5 Sleep mode and working mode](#)
  - [1.6 Button & LEDs](#)
  - [1.7 BLE connection](#)
  - [1.8 Pin Definitions](#)
  - [1.9 Mechanical](#)

- [2. Configure CPL03-LB to connect to LoRaWAN network](#)
  - [2.1 How it works](#)
  - [2.2 Quick guide to connect to LoRaWAN server \(OTAA\)](#)
  - [2.3 Uplink Payload](#)
    - [2.3.1 Device Status, FPORT=5](#)
    - [2.3.2 Sensor Configuration, FPORT=4](#)
    - [2.3.3 CPL01:Real-Time Open/Close Status, Uplink FPORT=2](#)
    - [2.3.4 CPL03:3 pulse mode, Uplink FPORT=6](#)
    - [2.3.5 Historical Open/Close Event, FPORT=3](#)
  - [2.4 Payload Decoder file](#)
  - [2.5 Datalog Feature](#)
    - [2.5.1 Ways to get datalog via LoRaWAN](#)
    - [2.5.2 Unix TimeStamp](#)
    - [2.5.3 Set Device Time](#)
    - [2.5.4 Poll sensor value](#)
  - [2.6 Frequency Plans](#)
- [3. Configure CPL03-LB](#)
  - [3.1 Configure Methods](#)
  - [3.2 General Commands](#)
  - [3.3 Commands special design for CPL03-LB](#)
    - [3.3.1 Set Transmit Interval Time](#)
    - [3.3.2 Set Power Output Duration](#)
    - [3.3.3 Enable / Disable Alarm](#)
    - [3.3.4 Alarm Base on Timeout](#)
    - [3.3.5 TTRIG timeout status alarm](#)
    - [3.3.6 Set trigger mode of PA8](#)
    - [3.3.7 Set trigger mode of PA4](#)
    - [3.3.8 Set trigger mode of PB15](#)
    - [3.3.9 Set the calculate flag](#)
    - [3.3.10 Set count number](#)
    - [3.3.11 Clear all counter values](#)
    - [3.3.12 Count Mod](#)
    - [3.3.13 Work Mod](#)
    - [3.3.14 Set Time Sync Mode](#)
- [4. Battery & Power Consumption](#)
- [5. OTA Firmware update](#)
- [6. FAQ](#)
  - [6.1 AT Commands input doesn't work](#)
  - [6.2 How to Connect Dry contacts or Wet Contacts](#)
  - [6.3 What is the maximum total number of pulses for CPL03? What happens after the maximum total number of pulses is reached?](#)
- [7. Order Info](#)
- [8. Packing Info](#)
- [9. Support](#)

# 1. Introduction

## 1.1 What is CPL03-LB LoRaWAN Pulse/Contact Sensor

The Dragino CPL03-LB is a **LoRaWAN Contact Sensor** for Internet of Things solution. It detects dry contact status, open time, open counts, and then upload to IoT server via LoRaWAN wireless protocol.

The CPL03-LB will send periodically data every day as well as for each dry contact action. It also counts the contact open times and calculate last open duration. User can also disable the uplink for each open/close event, instead, device can count each open event and uplink periodically.

The LoRa wireless technology used in CPL03-LB allows device to send data and reach extremely long ranges at low data-rates. It provides ultra-long range spread spectrum communication and high interference immunity whilst minimizing current consumption.

CPL03-LB **supports open alarm feature**, user can set open alarm for instant notice. CPL03-LB **supports Datalog feature**, it can save the data when there is no LoRaWAN network and uplink when network recover.

CPL03-LB is designed for outdoor use. It has a weatherproof enclosure and industrial level battery to work in low to high temperatures.

CPL03-LB **supports BLE configure** and **wireless OTA update** which make user easy to use.

CPL03-LB is powered by **8500mAh Li-SOC12 battery**, it is designed for long term use up to 5 years.

Each CPL03-LB is pre-load with a set of unique keys for LoRaWAN registrations, register these keys to local LoRaWAN server and it will auto connect after power on.

### CPL03-LB in LoRaWAN Network

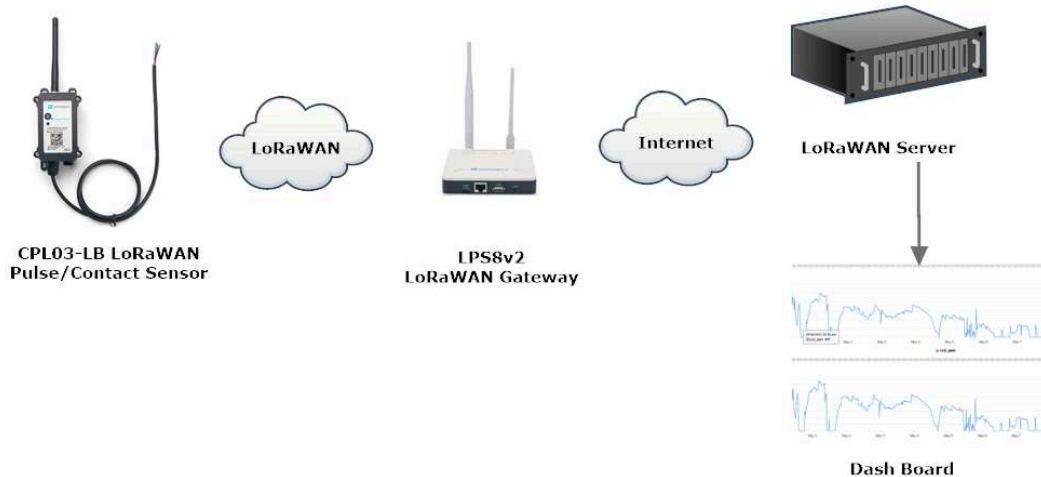

## 1.2 Features

- LoRaWAN 1.0.3 Class A
- Bands: CN470/EU433/KR920/US915/EU868/AS923/AU915/IN865
- Ultra-low power consumption
- Open/Close detect
- Open/Close statistics
- Supports open alarm feature
- Supports Datalog feature
- Support Bluetooth v5.1 and LoRaWAN remote configure
- Support wireless OTA update firmware
- Uplink on periodically and open/close event
- Downlink to change configure
- 8500mAh Battery for long term use

## 1.3 Specification

### Common DC Characteristics:

- Supply Voltage: built in 8500mAh Li-SOCI2 battery , 2.5v ~ 3.6v
- Operating Temperature: -40 ~ 85 °C

### LoRa Spec:

- Frequency Range, Band 1 (HF): 862 ~ 1020 Mhz
- Max +22 dBm constant RF output vs.
- RX sensitivity: down to -139 dBm.
- Excellent blocking immunity

### Battery:

- Li/SOCI2 un-chargeable battery
- Capacity: 8500mAh
- Self-Discharge: <1% / Year @ 25 °C
- Max continuously current: 130mA
- Max boost current: 2A, 1 second

### Power Consumption

- Sleep Mode: 5uA @ 3.3v
- LoRa Transmit Mode: 125mA @ 20dBm, 82mA @ 14dBm

## 1.4 Applications

- Open/Close Detection
- Pulse meter application
- Dry Contact Detection

## 1.5 Sleep mode and working mode

**Deep Sleep Mode:** Sensor doesn't have any LoRaWAN activate. This mode is used for storage and shipping to save battery life.

**Working Mode:** In this mode, Sensor will work as LoRaWAN Sensor to Join LoRaWAN network and send out sensor data to server. Between each sampling/tx/rx periodically, sensor will be in IDLE mode), in IDLE mode, sensor has the same power consumption as Deep Sleep mode.

## 1.6 Button & LEDs

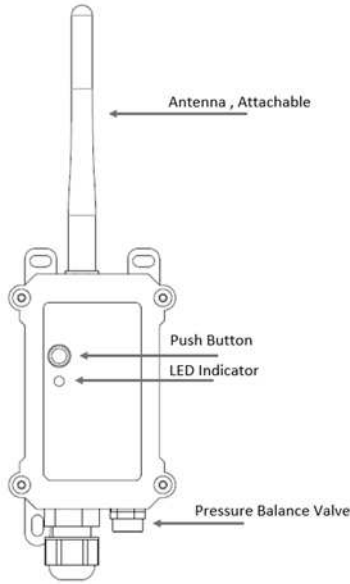

Behavior on ACT	Function	Action
Pressing ACT between 1s < time < 3s	Send an uplink	If sensor is already Joined to LoRaWAN network, sensor will send an uplink packet, <b>blue led</b> will blink once. Meanwhile, BLE module will be active and user can connect via BLE to configure device.
Pressing ACT for more than 3s	Active Device	<b>Green led</b> will fast blink 5 times, device will enter <b>OTA mode</b> for 3 seconds. And then start to JOIN LoRaWAN network. <b>Green led</b> will solidly turn on for 5 seconds after joined in network. Once sensor is active, BLE module will be active and user can connect via BLE to configure device, no matter if device join or not join LoRaWAN network.
Fast press ACT 5 times.	Deactivate Device	<b>Red led</b> will solid on for 5 seconds. Means device is in Deep Sleep Mode.

## 1.7 BLE connection

CPL03-LB support BLE remote configure.

BLE can be used to configure the parameter of sensor or see the console output from sensor. BLE will be only activate on below case:

- Press button to send an uplink
- Press button to active device.
- Device Power on or reset.

If there is no activity connection on BLE in 60 seconds, sensor will shut down BLE module to enter low power mode.

## 1.8 Pin Definitions



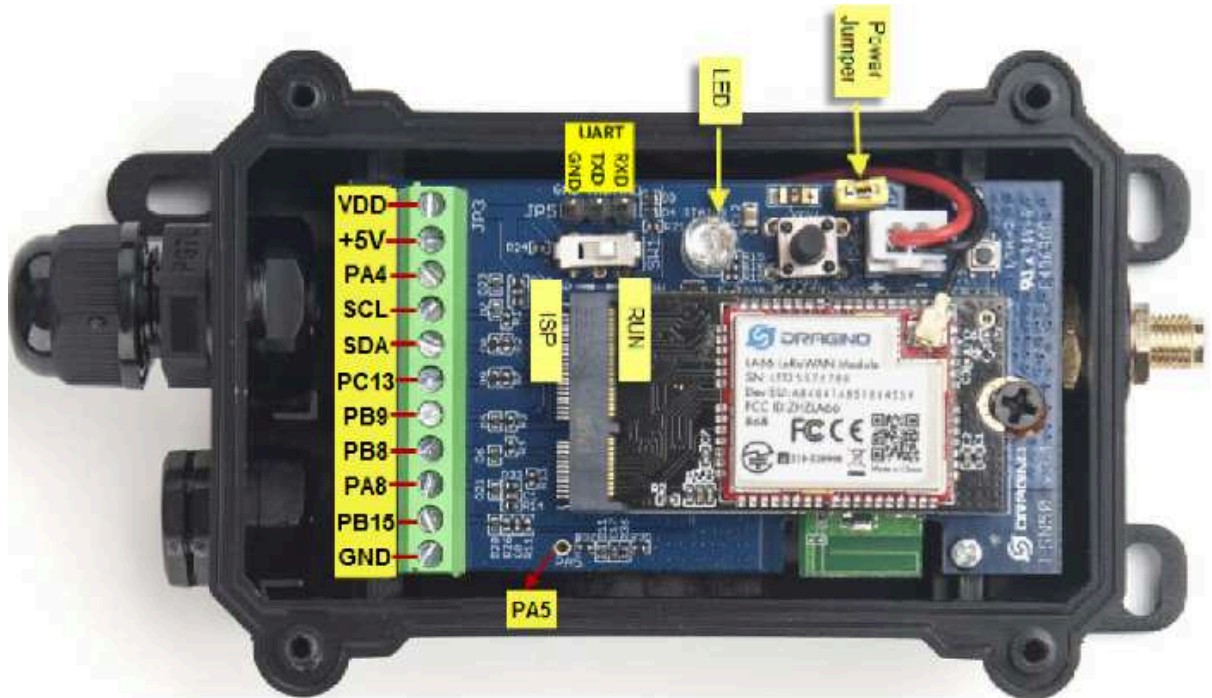

## 1.9 Mechanical

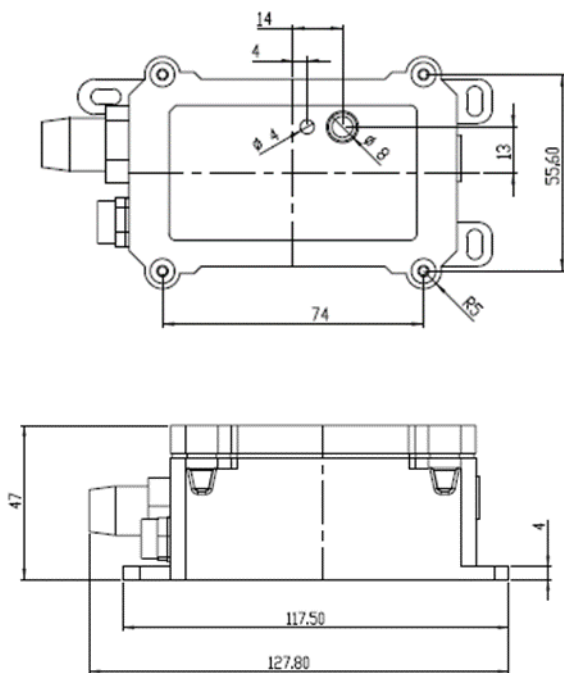

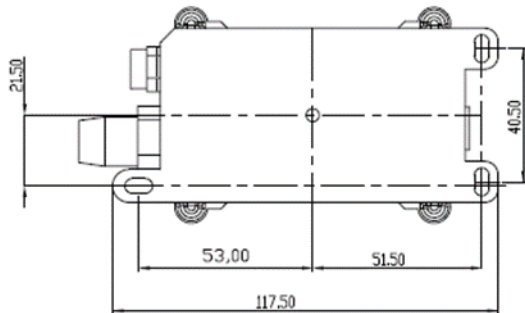

## 2. Configure CPL03-LB to connect to LoRaWAN network

### 2.1 How it works

The CPL03-LB is configured as **LoRaWAN OTAA Class A** mode by default. It has OTAA keys to join LoRaWAN network. To connect a local LoRaWAN network, you need to input the OTAA keys in the LoRaWAN IoT server and press the button to activate the CPL03-LB. It will automatically join the network via OTAA and start to send the sensor value. The default uplink interval is 2 hours.

### 2.2 Quick guide to connect to LoRaWAN server (OTAA)

Following is an example for how to join the [TTN v3 LoRaWAN Network](#). Below is the network structure; we use the [LPS8v2](#) as a LoRaWAN gateway in this example.

The LPS8v2 is already set to connected to [TTN network](#), so what we need to now is configure the TTN server.

### CPL03-LB in LoRaWAN Network

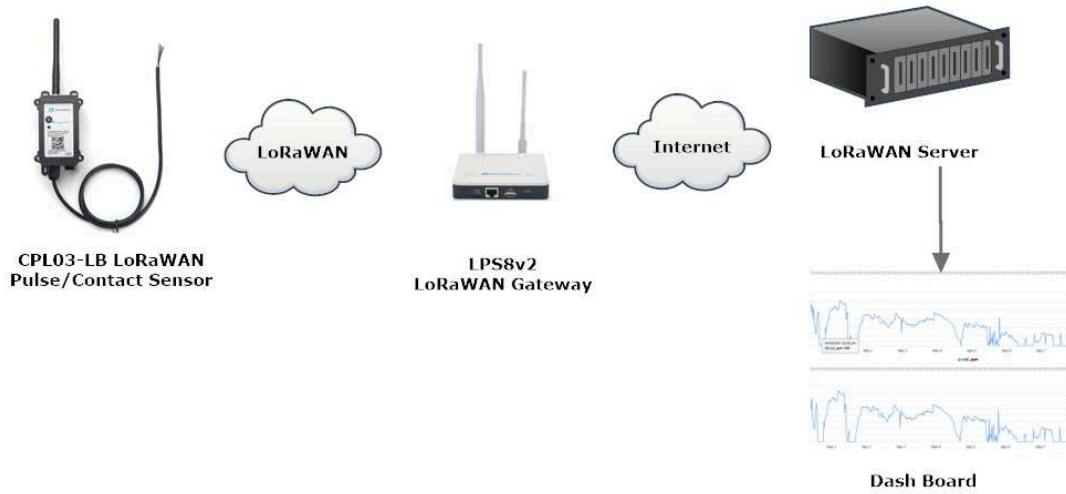

**Step 1:** Create a device in TTN with the OTAA keys from CPL03-LB.

Each CPL03-LB is shipped with a sticker with the default device EUI as below:

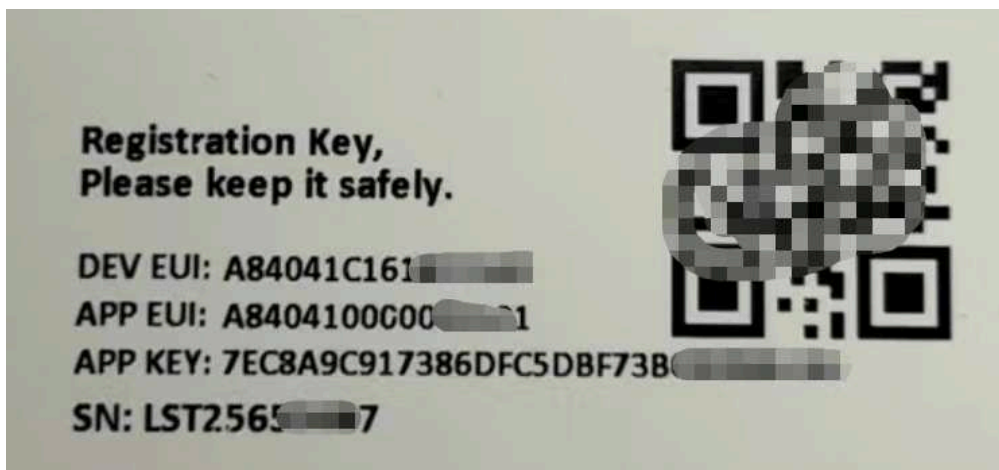

You can enter this key in the LoRaWAN Server portal. Below is TTN screen shot:

[Register the device](#)

## Register end device

From The LoRaWAN Device Repository [Manually](#)

### Preparation

#### Activation mode \*

- Over the air activation (OTAA)
- Activation by personalization (ABP)
- Multicast
- Do not configure activation

#### LoRaWAN version ⓘ \*

MAC V1.0.3



#### Network Server address

eu1.cloud.thethings.network

#### Application Server address

eu1.cloud.thethings.network

#### External Join Server ⓘ

Enabled

#### Join Server address

eu1.cloud.thethings.network

Start



## Add APP EUI and DEV EUI

## Register end device

From The LoRaWAN Device Repository

**Manually**

- 1 Basic settings**  
End device ID's, Name and Description
- 2 Network layer settings**  
Frequency plan, regional parameters, end device class and session keys.
- 3 Join settings**  
Root keys, NetID and kek labels.

End device ID \*

lsnPK01

AppEUI \*

.. .. . 00

DevEUI \*

.. .. .

End device name

LSNPK01

End device description

Description for my new end device

Optional end device description; can also be used to save notes about the end device.

[Network layer settings >](#)

### Add APP EUI in the application

## Register end device

From The LoRaWAN Device Repository [Manually](#)

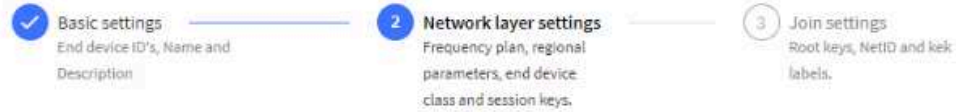

Frequency plan \*

Europe 863-870 MHz (SF12 for RX2)

LoRaWAN version \*

MAC V1.0.3

Regional Parameters version \*

PHY V1.0.3 REV A

LoRaWAN class capabilities

- Supports class B
- Supports class C

Advanced settings

[< Basic settings](#) [Join settings >](#)

### Add APP KEY

## Register end device

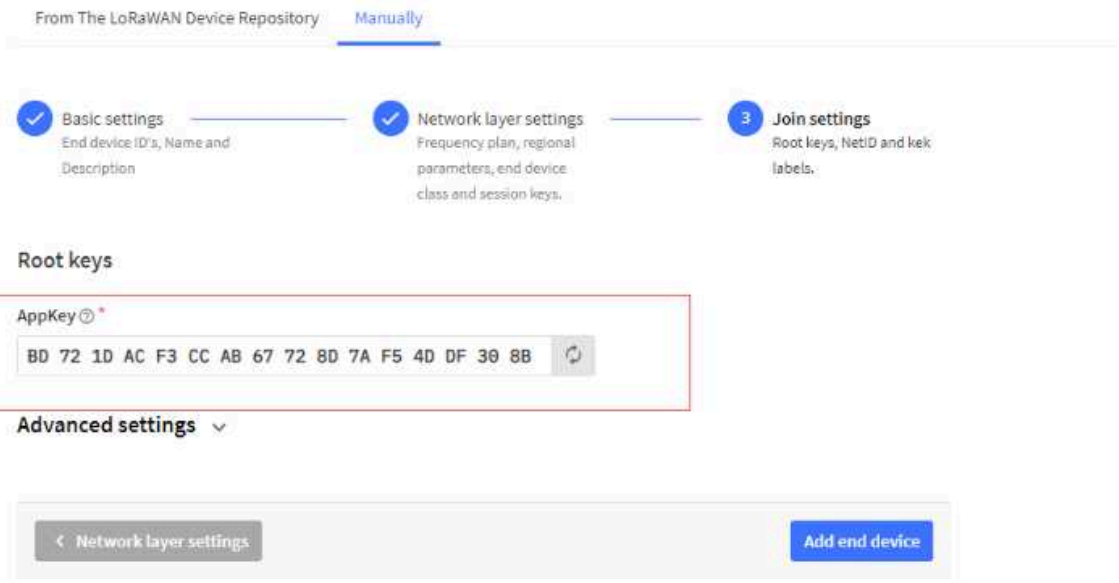

### Step 2: Activate on CPL03-LB

Press the button for 5 seconds to activate the CPL03-LB.

**Green led** will fast blink 5 times, device will enter **OTA mode** for 3 seconds. And then start to JOIN LoRaWAN network. **Green led** will solidly turn on for 5 seconds after joined in network.

After join success, it will start to upload messages to TTN and you can see the messages in the panel.

## 2.3 Uplink Payload

### 2.3.1 Device Status, FPORT=5

Include device configure status. Once CPL03-LB Joined the network, it will uplink this message to the server. After that, CPL03-LB will uplink Device Status every 12 hours.

Users can also use the downlink command(**0x26 01**) to ask CPL03-LB to resend this uplink. This uplink payload also includes the DeviceTimeReq to get time.

The Payload format is as below.

Device Status (FPORT=5)					
Size (bytes)	1	2	1	1	2
Value	Sensor Model	Firmware Version	Frequency Band	Sub-band	BAT

Example parse in TTNv3

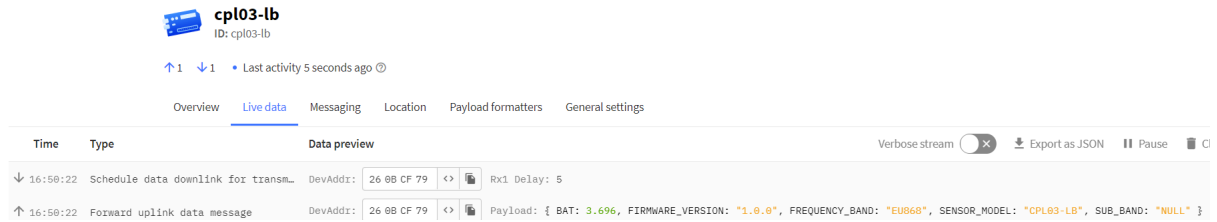

**Sensor Model:** For CPL03-LB, this value is 0x20

**Firmware Version:** 0x0100, Means: v1.0.0 version

### Frequency Band:

0x01: EU868

0x02: US915

0x03: IN865

0x04: AU915

0x05: KZ865

0x06: RU864

0x07: AS923

0x08: AS923-1

0x09: AS923-2

0x0a: AS923-3

0x0b: CN470

0x0c: EU433

0x0d: KR920

0x0e: MA869

### Sub-Band:

AU915 and US915: value 0x00 ~ 0x08

CN470: value 0x0B ~ 0x0C

Other Bands: Always 0x00

### Battery Info:

Check the battery voltage.

Ex1: 0x0B45 = 2885mV

Ex2: 0x0B49 = 2889mV

## 2.3.2 Sensor Configuration, FPORT=4



CPL03-LB will only send this command after getting the downlink command (**0x26 02**) from the server.

Sensor Configuration FPORT=4								
<b>Size(bytes)</b>	<b>3</b>	<b>1</b>	<b>1</b>	<b>2</b>	<b>1</b>	<b>1</b>	<b>1</b>	<b>1</b>
<b>Value</b>	TDC (unit:sec)	Disalarm	Keep status	Keep time (unit: sec)	Trigger1 mod(PA8)	Trigger2 mod(PA4)	Trigger3 mod(PB15)	Alarm interval(unit: min)

Example parse in TTNv3

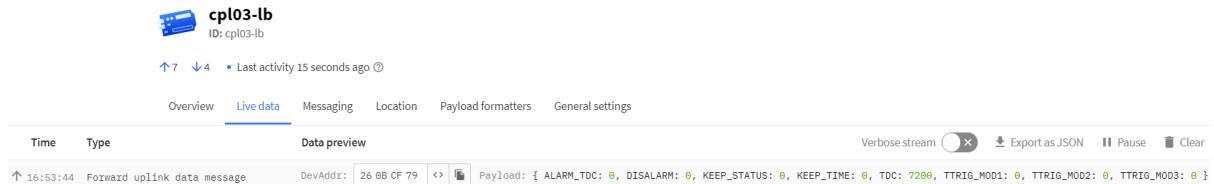

- **TDC: (default: 0x001C20)**

Uplink interval for the total pulse count, default value is 0x001C20 which is 7200 seconds = 2 hours.

- **Disalarm: (default: 0)**

If **Disalarm = 1**, CPL03-LB will only send uplink at every TDC periodically. This is normally use for pulse meter application, in this application, there are many disconnect/connect event, and platform only care about the total number of pulse.

If **Disalarm = 0**, CPL03-LB will send uplink at every TDC periodically.

- **Keep Status & Keep Time**

Shows the configure value of [Alarm Base on Timeout Feature](#)

- **Trigger1 mod (default: 0)**

The trigger mode of PA8 pin.

0: The pulse count will increment by one after a close to open event.

1: The pulse count will increment by one after a open to close event.

- **Trigger2 mod (default: 0)**

The trigger mode of PA4 pin. Only valid when AT+MOD=2.

0: The pulse count will increment by one after a close to open event.

1: The pulse count will increment by one after a open to close event.

- **Trigger3 mod (default: 0)**

The trigger mode of PB15 pin. Only valid when AT+MOD=2.

0: The pulse count will increment by one after a close to open event.

1: The pulse count will increment by one after a open to close event.

- **Alarm interval(default: 0)**

When the state of the door sensor has not been changed after the timeout alarm, the device will send an uplink every alarm interval. It will stop the alarm until the state of the door sensor is changed after the timeout alarm.

### 2.3.3 CPL01:Real-Time Open/Close Status, Uplink FPORT=2

Default working mode, **AT+MOD=1:**

The wiring of the Real-Time Open/Close Status mode is as follows:

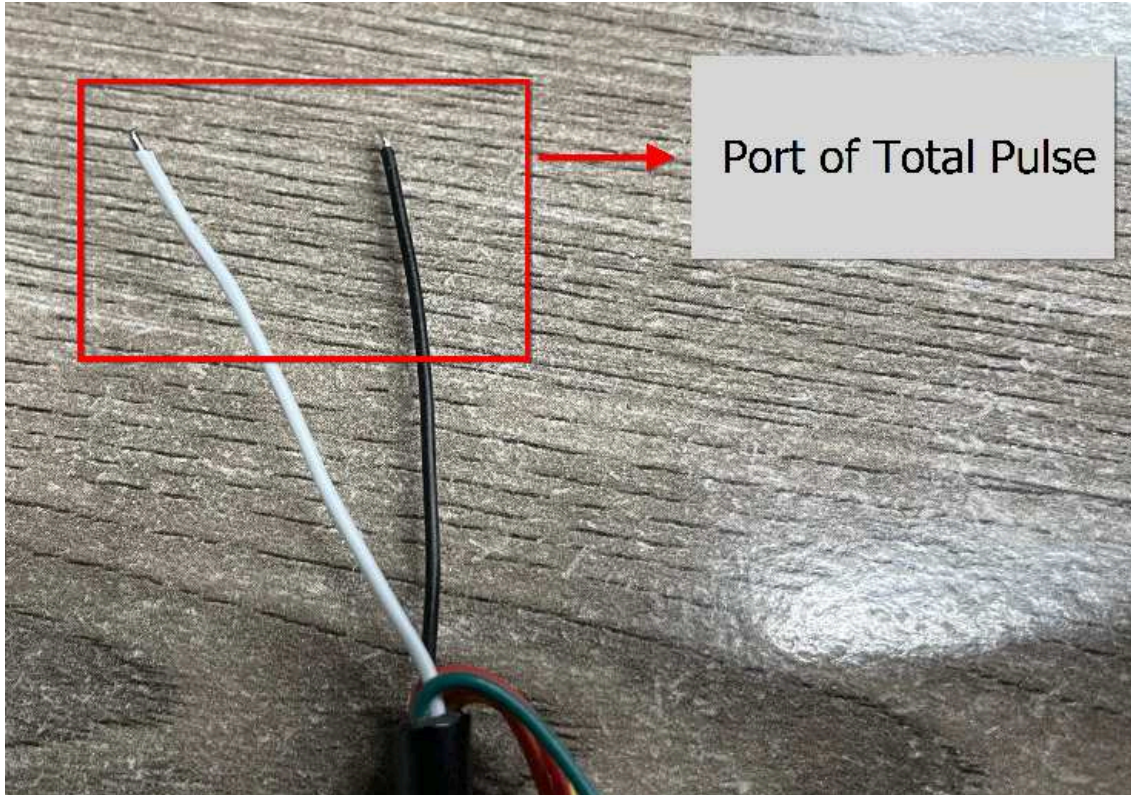

CPL03-LB will send this uplink **after** Device Status once join the LoRaWAN network successfully. And CPL03-LB will:

periodically send this uplink every 2 hours, this interval [can be changed](#).

Uplink Payload totals 11 bytes.

Real-Time Open/Close Status, FPORT=2				
Size(bytes)	1	3	3	4
Value	Status & <a href="#">Alarm</a>	Total pulse	The last duration (unit: sec)	<a href="#">Unix TimeStamp</a>

#### Status & Alarm field:

Size(bit)	[bit7:bit6]	bit5	bit4	bit3	bit2	bit1	bit0
Value	Reserve	Count mod	TDC flag 0:No;1:Yes	work mod	Trigger1 mod	Alarm: 0: No Alarm; 1: Alarm	Status 0: Close; 1: Open

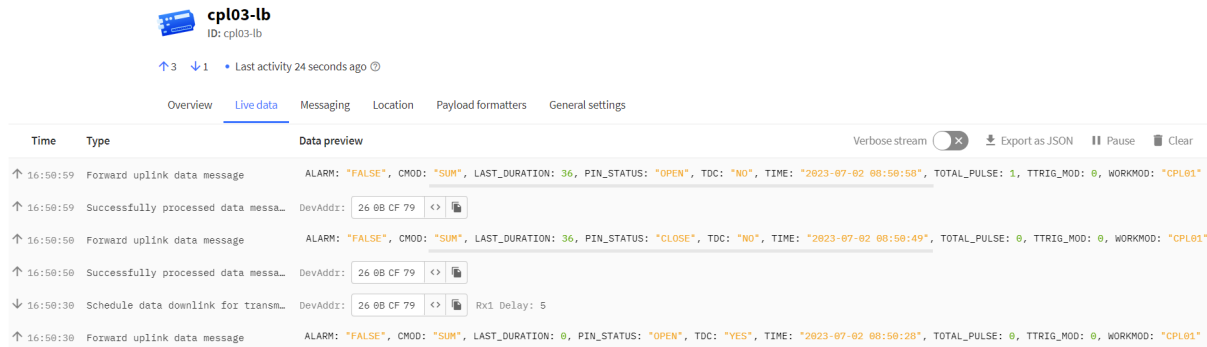

- **Count mod:Default=0**

0: Uplink total open door times since factory

1 : Uplink total open door times since last FPORT=2 uplink.

- **TDC flag**

When the flag is 1, it means sending packets at normal time intervals.

Otherwise, it is a packet sent at non-TDC time.

- **Work mod**

0: CPL01-Real-Time Open/Close Status mode.

1: CPL03-3 pulse mode.

- **Trigger1 mod**

0: The pulse count will increment by one after a close to open event and the last duration is for the open event.

1: The pulse count will increment by one after a open to close event and the last duration is for the close event.

- **Alarm**

See [Alarm Base on Timeout](#)

- **Status**

0: Open

1: Close

- **Total pulse**

Total pulse/counting base on dry [contact trigger event](#)

Range (3 Bytes) : 0x000000 ~ 0xFFFFFFFF . Max: 16777215

- **The last duration**

1) **AT+TTRMOD1=0** : Dry Contact last open duration.(Unit: sec)

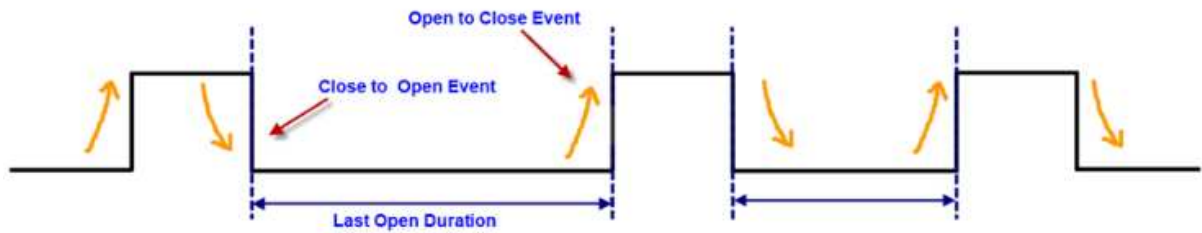

2) **AT+TTRMOD1=1** : Dry Contact last close duration.(Unit: sec)

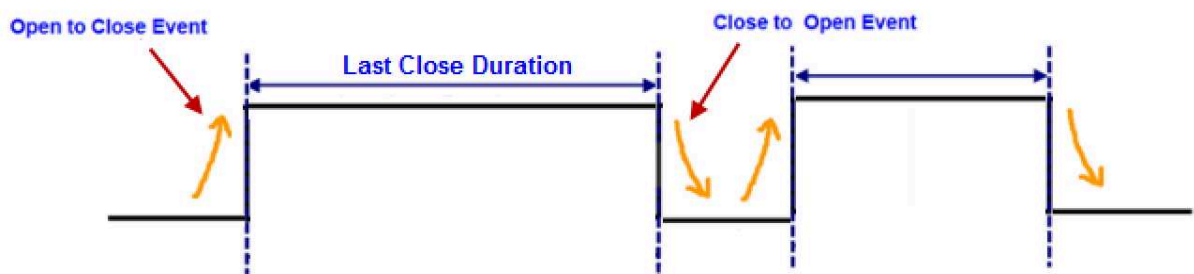

### 2.3.4 CPL03:3 pulse mode, Uplink FPORT=6

To use this working mode, you need to set **AT+MOD=2**.

The wiring of the three pulse counting mode are as follows:



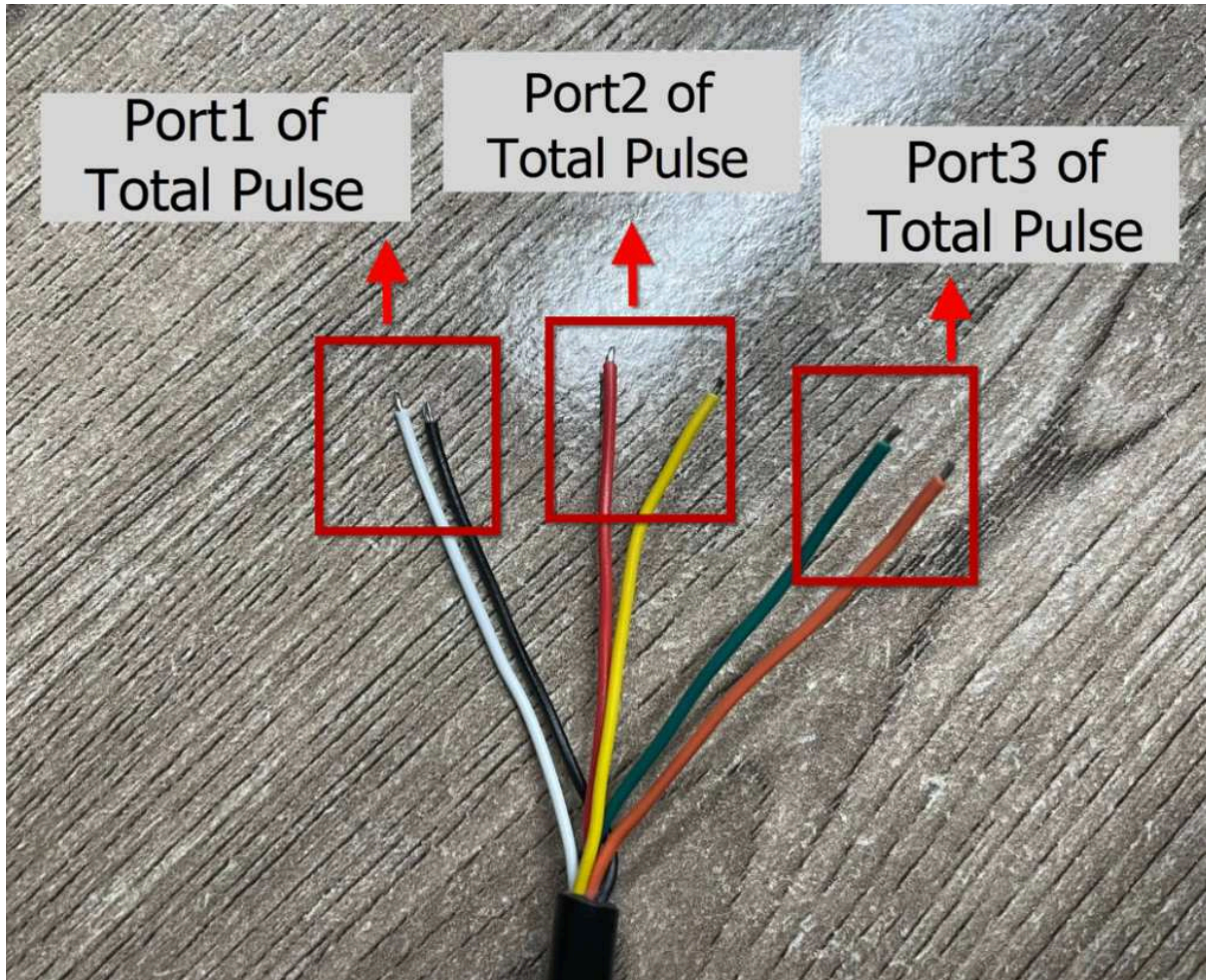

Size(bytes)	1	3	3	3
Value	Status	Port1 Total Pulse(PA8)	Port2 Total Pulse(PA4)	Port3 Total Pulse(PB15)

**Status:**

Size(bit)	[bit7:bit6]	bit5	bit4	bit3	[bit2:bit0]
Value	Reserve	Count mod	TDC flag 0:No; 1:Yes	work mod	Calculate Flag

**Max COUNT for each port is 16777215. Exceed this number will reset to 1.**

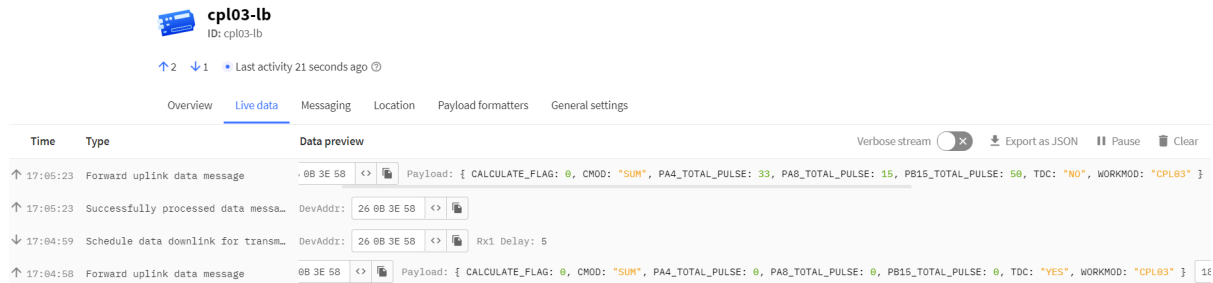

- **Count mod:Default=0**

0: Uplink total open door times since factory

1 : Uplink total open door times since last FPORT=2 uplink.

- **TDC flag**

When the flag is 1, it means sending packets at normal time intervals.

Otherwise, it is a packet sent at non-TDC time.

- **Work mod**

0: CPL01-Real-Time Open/Close Status mode.

1: CPL03-3 pulse mode.

- **Calculate Flag**

The calculate flag is a user define field, IoT server can use this field to handle different meter with different pulse factor. For example, if there are 100 water meters, meter 1 ~50 are 1 liter/pulse and meter 51 ~ 100 has 1.5 liter/pulse.

User can set calculate flag to 1 for meter 1~50 and 2 for meter 51 ~ 100, So IoT Server can use this field for calculation.

Default value: 0.

Range (3 bits): (b)000 ~ (b) 111

Refer: [Set Calculate Flag](#)

- **Port1 Total Pulse(PA8 of pin)**

Range (3 Bytes) : 0x000000 ~ 0xFFFFFFFF . Max: 16777215.Exceed this number will reset to 1.

- **Port2 Total Pulse(PA4 of pin)**

Range (3 Bytes) : 0x000000 ~ 0xFFFFFFFF . Max: 16777215.Exceed this number will reset to 1.

- **Port3 Total Pulse(PB15 of pin)**

Range (3 Bytes) : 0x000000 ~ 0xFFFFFFFF . Max: 16777215.Exceed this number will reset to 1.

**Related AT Command:**

**AT+TTRMOD1: Port1 count mode; 0: Signal falling edge(Default), 1: Signal raising edge**

AT+TTRMOD1=0 Downlink Command: 0xA4 01 00

AT+TTRMOD1=1 Downlink Command: 0xA4 01 01

**AT+TTRMOD2: Port2 count mode; 0: Signal falling edge(Default), 1: Signal raising edge**

AT+TTRMOD2=0 Downlink Command: 0xA4 02 00

AT+TTRMOD2=1 Downlink Command: 0xA4 02 01

**AT+TTRMOD3: Port3 count mode; 0: Signal falling edge(Default), 1: Signal raising edge**

AT+TTRMOD3=0 Downlink Command: 0xA4 03 00

AT+TTRMOD3=1 Downlink Command: 0xA4 03 01

**AT+CALCFLAG: Calculate Flag ( Default : 0 )**

AT+CALCFLAG=aa Downlink Command: 0xA5 aa

**AT+COUNTMOD: Accumulative Mode; 0: Accumulative (Default),1: Reset after uplink.**

AT+COUNTMOD=0 Downlink Command: 0x0B 00

AT+COUNTMOD=1 Downlink Command: 0x0B 01

**AT+SETCNT: Set count value**

AT+SETCNT=1,aa Downlink Command: 0xA6 01 aa aa aa

AT+SETCNT=2,aa Downlink Command: 0xA6 02 aa aa aa

AT+SETCNT=3,aa Downlink Command: 0xA6 03 aa aa aa

### 2.3.5 Historical Open/Close Event, FPORT=3

CPL03-LB stores sensor values and users can retrieve these history values via the [downlink command](#).

The historical payload includes one or multiplies entries and every entry has the same payload as Real-Time open/close status.

- Each data entry is 11 bytes and has the same structure as [Real-Time open/close status](#), to save airtime and battery, CPL03-LB will send max bytes according to the current DR and Frequency bands.

For example, in the US915 band, the max payload for different DR is:

- a) **DR0**: max is 11 bytes so one entry of data
- b) **DR1**: max is 53 bytes so devices will upload 4 entries of data (total 44 bytes)
- c) **DR2**: total payload includes 11 entries of data
- d) **DR3**: total payload includes 22 entries of data.

If CPL03-LB doesn't have any data in the polling time. It will uplink 11 bytes of 0

**Downlink:**

0x31 64 AE 52 C2 64 AE 54 E0 05

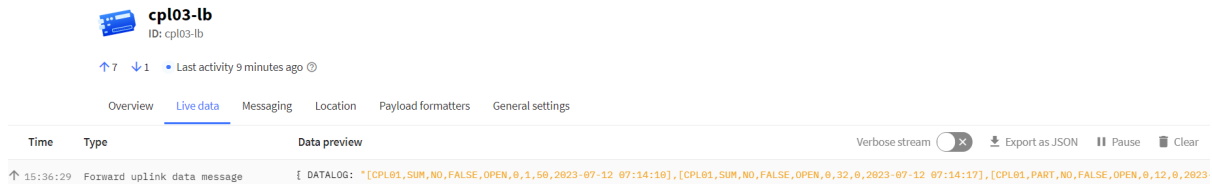

### Uplink:

41 00 00 01 00 00 32 64 AE 52 C2 41 00 00 20 00 00 00 64 AE 52 C9 61 00 00 0C 00 00 00 64 AE 53 45 64 00 00  
12 00 00 3D 64 AE 54 11 78 00 00 00 00 00 64 AE 54 4B 68 00 00 17 00 00 05 64 AE 54 86 4C 00 00 17 00 00  
05 64 AE 54 AB 4C 00 00 17 00 00 05 64 AE 54 B7 4C 00 00 17 00 00 05 64 AE 54 E0

### Parsed Value:

#### CPL01:

[WORKMOD, COUNTMOD, TDC\_FLAG, ALARM, STATUS, TRIGGER1\_MOD, TOTAL\_PULSE,  
LAST\_DURATION, TIME]

[CPL01,SUM,NO,FALSE,OPEN,0,1,50,2023-07-12 07:14:10],

[CPL01,SUM,NO,FALSE,OPEN,0,32,0,2023-07-12 07:14:17],

[CPL01,PART,NO,FALSE,OPEN,0,12,0,2023-07-12 07:16:21],

[CPL01,PART,NO,FALSE,CLOSE,1,18,61,2023-07-12 07:19:45],

**CPL03:Due to the limitation of byte length, only count value 1 and count value 2 are sent in the data record data.**

[WORKMOD, COUNTMOD, TDC\_FLAG, CALCULATE\_FLAG, PORT1\_TOTAL\_PULSE,  
PORT2\_TOTAL\_PULSE, TIME]

[CPL03,PART,YES,0,0,0,2023-07-12 07:20:43],

[CPL03,PART,NO,0,23,5,2023-07-12 07:21:42],

[CPL03,SUM,NO,4,23,5,2023-07-12 07:22:19],

[CPL03,SUM,NO,4,23,5,2023-07-12 07:22:31],

[CPL03,SUM,NO,4,23,5,2023-07-12 07:23:12],



```
Stop Tx events when read sensor data
0001 2023/7/12 07:14:10 bat:3654 cmod:0 status:open total_pulse:1 last_open_duration:50 alarm:false tdc:no
0002 2023/7/12 07:14:17 bat:3654 cmod:0 status:open total_pulse:32 last_open_duration:0 alarm:false tdc:no
0003 2023/7/12 07:16:21 bat:3654 cmod:1 status:open total_pulse:12 last_open_duration:0 alarm:false tdc:no
0004 2023/7/12 07:19:45 bat:3654 cmod:1 status:close total_pulse:18 last_close_duration:61 alarm:false tdc:no
0005 2023/7/12 07:20:48 bat:3654 cmod:1 cal_flag:0 total_pulse1:0 total_pulse2:0 total_pulse3:0 tdc:yes
0006 2023/7/12 07:21:42 bat:3654 cmod:1 cal_flag:0 total_pulse1:23 total_pulse2:5 total_pulse3:41 tdc:no
0007 2023/7/12 07:22:19 bat:3654 cmod:0 cal_flag:4 total_pulse1:23 total_pulse2:5 total_pulse3:41 tdc:no
0008 2023/7/12 07:22:31 bat:3654 cmod:0 cal_flag:4 total_pulse1:23 total_pulse2:5 total_pulse3:41 tdc:no
0009 2023/7/12 07:23:12 bat:3654 cmod:0 cal_flag:4 total_pulse1:23 total_pulse2:5 total_pulse3:50 tdc:no
Start Tx events

OK
```

## 2.4 Payload Decoder file

In TTN, use can add a custom payload so it shows friendly reading

In the page [Applications --> Payload Formats --> Custom --> decoder](#) to add the decoder from: <https://github.com/dragino/dragino-end-node-decoder>

## 2.5 Datalog Feature

Datalog Feature is to ensure IoT Server can get all sampling data from Sensor even if the LoRaWAN network is down. For each sampling, CPL03-LB will store the reading for future retrieving purposes.

**Note:After the device is reset, in cumulative counting mode ,the last stored count value will be read as the initial value.**

### 2.5.1 Ways to get datalog via LoRaWAN

Set PNACKMD=1, CPL03-LB will wait for ACK for every uplink, when there is no LoRaWAN network,CPL03-LB will mark these records with non-ack messages and store the sensor data, and it will send all messages (10s interval) after the network recovery.

- a) CPL03-LB will do an ACK check for data records sending to make sure every data arrive server.
- b) CPL03-LB will send data in **CONFIRMED Mode** when PNACKMD=1, but CPL03-LB won't re-transmit the packet if it doesn't get ACK, it will just mark it as a NONE-ACK message. In a future uplink if CPL03-LB gets a ACK, CPL03-LB will consider there is a network connection and resend all NONE-ACK messages.

Below is the typical case for the auto-update datalog feature (Set PNACKMD=1)

New Feature for ColdChain  
solve network coverage issue & save cost

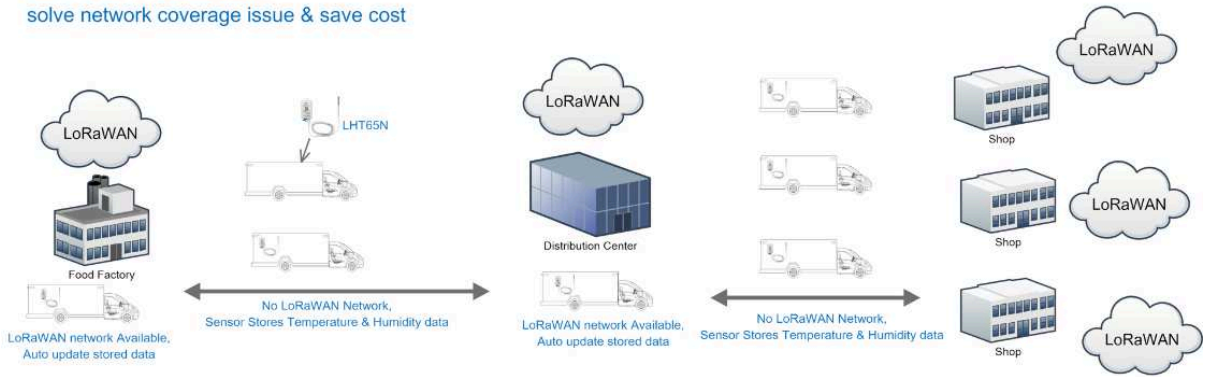

## 2.5.2 Unix TimeStamp

CPL03-LB uses Unix TimeStamp format based on

Size (bytes)	4	1
DeviceTimeAns Payload	32-bit unsigned integer : Seconds since epoch*	8bits unsigned integer: fractional-second in $\frac{1}{2}^8$ second steps

Figure 10 : DeviceTimeAns payload format

User can get this time from link: <https://www.epochconverter.com/> :

Below is the converter example

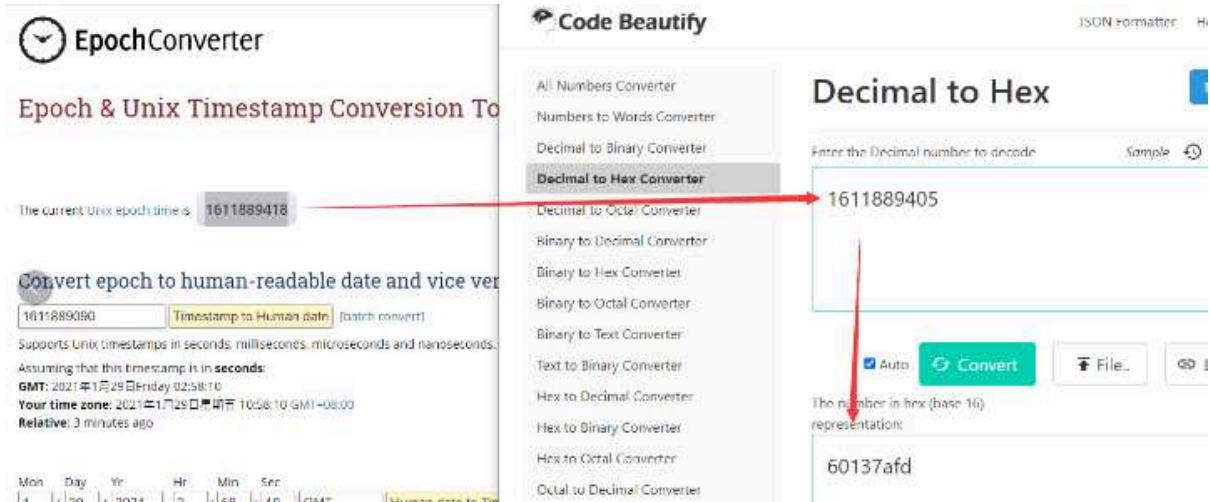

So, we can use AT+TIMESTAMP=1611889405 or downlink 3060137afd00 to set the current time 2021 – Jan -- 29 Friday 03:03:25

### 2.5.3 Set Device Time

User need to set **SYNCMOD=1** to enable sync time via MAC command.

Once CPL03-LB Joined LoRaWAN network, it will send the MAC command (DeviceTimeReq) and the server will reply with (DeviceTimeAns) to send the current time to CPL03-LB. If CPL03-LB fails to get the time from the server, CPL03-LB will use the internal time and wait for next time request (AT+SYNCTDC to set the time request period, default is 10 days).

**Note: LoRaWAN Server need to support LoRaWAN v1.0.3(MAC v1.0.3) or higher to support this MAC command feature, Chirpstack,TTN V3 v3 and loriot support but TTN V3 v2 doesn't support. If server doesn't support this command, it will through away uplink packet with this command, so user will lose the packet with time request for TTN V3 v2 if SYNCMOD=1.**

### 2.5.4 Poll sensor value

Users can poll sensor values based on timestamps. Below is the downlink command.

Downlink Command to poll Open/Close status (0x31)			
<b>1byte</b>	<b>4bytes</b>	<b>4bytes</b>	<b>1byte</b>
31	Timestamp start	Timestamp end	Uplink Interval

Timestamp start and Timestamp end-use Unix TimeStamp format as mentioned above. Devices will reply with all data logs during this period, using the uplink interval.

For example, downlink command **31 618E5740 618E8170 05**

Is to check 2021/11/12 12:00:00 to 2021/11/12 15:00:00's data

Uplink Internal =5s, means CPL03-LB will send one packet every 5s. range 5~255s.

## 2.6 Frequency Plans

The CPL03-LB uses OTAA mode and below frequency plans by default. If user want to use it with different frequency plan, please refer the AT command sets.

<http://wiki.dragino.com/xwiki/bin/view/Main/End%20Device%20Frequency%20Band/>

## 3. Configure CPL03-LB

### 3.1 Configure Methods

CPL03-LB supports below configure method:

- AT Command via Bluetooth Connection (**Recommended**): [BLE Configure Instruction](#).
- AT Command via UART Connection : See [UART Connection](#).
- LoRaWAN Downlink. Instruction for different platforms: See [IoT LoRaWAN Server](#) section.

### 3.2 General Commands

These commands are to configure:

- General system settings like: uplink interval.
- LoRaWAN protocol & radio related command.

They are same for all Dragino Devices which support DLWS-005 LoRaWAN Stack. These commands can be found on the wiki:

<http://wiki.dragino.com/xwiki/bin/view/Main/End%20Device%20AT%20Commands%20and%20Downlink%20Command/>

### 3.3 Commands special design for CPL03-LB

These commands only valid for CPL03-LB, as below:

#### 3.3.1 Set Transmit Interval Time

Feature: Change LoRaWAN End Node Transmit Interval.

##### AT Command: AT+TDC

Command Example	Function	Response
AT+TDC=?	Show current transmit Interval	30000 OK the interval is 30000ms = 30s
AT+TDC=60000	Set Transmit Interval	OK Set transmit interval to 60000ms = 60 seconds

##### Downlink Command: 0x01

Format: Command Code (0x01) followed by 3 bytes time value.

If the downlink payload=0100003C, it means set the END Node's Transmit Interval to 0x00003C=60(S), while type code is 01.

- Example 1: Downlink Payload: 01 00 00 1E // Set Transmit Interval (TDC) = 30 seconds

- Example 2: Downlink Payload: 01 00 00 3C // Set Transmit Interval (TDC) = 60 seconds

### 3.3.2 Set Power Output Duration

Control the output duration 5V . Before each sampling, device will

1. first enable the power output to external sensor,
2. keep it on as per duration, read sensor value and construct uplink payload
3. final, close the power output.

**AT Command: AT+5VT**

Command Example	Function	Response
AT+5VT=?	Show 5V open time.	0 (default) OK
AT+5VT=500	Close after a delay of 500 milliseconds.	OK

**Downlink Command: 0x07**

Format: Command Code (0x07) followed by 2 bytes.

The first and second bytes are the time to turn on.

- Example 1: Downlink Payload: 07 00 00 ---> AT+5VT=0
- Example 2: Downlink Payload: 07 01 F4 ---> AT+5VT=500

### 3.3.3 Enable / Disable Alarm

**It only takes effect when AT+MOD=1.**

Feature: Enable/Disable Alarm for open/close event. Default value 0.

**AT Command:**

Command Example	Function	Response
AT+DISALARM=1	End node will only send packets in TDC time.	OK
AT+DISALARM=0	End node will send packets in TDC time or status change for door sensor	OK

**Downlink Command:**

**0xA7 01** // Same As AT+DISALARM=1

**0xA7 00** // Same As AT+DISALARM=0

### 3.3.4 Alarm Base on Timeout

**It only takes effect when AT+MOD=1.**

CPL03-LB can monitor the timeout for a status change, this feature can be used to monitor some events such as door opening too long etc. Related Parameters are:

#### 1. Keep Status: Status to be monitor

**Keep Status = 1:** Monitor Close to Open event

**Keep Status = 0:** Monitor Open to Close event

#### 2. Keep Time: Timeout to send an Alarm

Range 0 ~ 65535(0xFFFF) seconds.

If **keep time = 0**, Disable Alarm Base on Timeout feature.

If **keep time > 0**, device will monitor the keep status event and send an alarm when status doesn't change after timeout.

**AT Command** to configure:

**AT+TTRIG=1,30** --> When the **Keep Status** change from connect to disconnect, and device remains in disconnect status for more than 30 seconds. CPL03-LB will send an uplink packet, the **Alarm bit** (the second bit of 1<sup>st</sup> byte of payload) on this uplink packet is set to 1.

**AT+TTRIG=0,0** --> Default Value, disable timeout Alarm.

**Downlink Command** to configure:

**Command: 0xA9 aa bb cc**

**A9:** Command Type Code

**aa:** status to be monitored

**bb cc:** timeout.

If user send 0xA9 01 00 1E: equal to AT+TTRIG=1,30

Or

0xA9 00 00 00: Equal to AT+TTRIG=0,0. Disable timeout Alarm.

### 3.3.5 TTRIG timeout status alarm

**It only takes effect when AT+MOD=1.**

It needs to be used with AT+TTRIG . When TTRIG times out and causes an alarm, and the status does not change subsequently, an alarm packet will be sent at the alarm interval.

**AT Command:**

Command Example	Function	Response
AT+TTRALARM=0	Disable continuous alarm.	OK(default)
AT+TTRALARM=60	The alarm interval is 60 minutes (unit: minutes)	OK

**Downlink Command:**

Example: 0C aa => AT+TTRALARM= aa

### 3.3.6 Set trigger mode of PA8

Feature: Set the trigger interrupt mode.

**AT Command: AT+TTRMOD1**

Command Example	Function	Response
AT+TTRMOD1=1	Count and trigger from open to close (rising edge)	OK
AT+TTRMOD1=0	Count and trigger from close to open (falling edge)	OK(default)

**Downlink Command:**

- **Example1:** 0xA4 01 01 // Same as AT+ TTRMOD1 =1
- **Example2:** 0xA4 01 00 // Same as AT+ TTRMOD1 =0

### 3.3.7 Set trigger mode of PA4

It only takes effect when **AT+MOD=2**.

Feature: Set the trigger interrupt mode.

**AT Command: AT+TTRMOD2**

Command Example	Function	Response
AT+TTRMOD2=1	Count and trigger from open to close (rising edge)	OK
AT+TTRMOD2=0	Count and trigger from close to open (falling edge)	OK(default)

**Downlink Command:**

- **Example1:** 0xA4 02 01 // Same as AT+ TTRMOD2 =1
- **Example2:** 0xA4 02 00 // Same as AT+ TTRMOD2 =0

### 3.3.8 Set trigger mode of PB15

It only takes effect when **AT+MOD=2**.

Feature: Set the trigger interrupt mode.

**AT Command: AT+TTRMOD3**

Command Example	Function	Response
AT+TTRMOD3=1	Count and trigger from open to close (rising edge)	OK
AT+TTRMOD3=0	Count and trigger from close to open (falling edge)	OK(default)

**Downlink Command:**

- **Example1:** 0xA4 03 01 // Same as AT+ TTRMOD3 =1
- **Example2:** 0xA4 03 00 // Same as AT+ TTRMOD3 =0

### 3.3.9 Set the calculate flag

It only takes effect when **AT+MOD=2**.

Feature: Set the calculate flag.(Range is 0 to 7)

**AT Command: AT+CALCFLAG**

Command Example	Function	Response
AT+CALCFLAG =0	Set the calculate flag to 0.	OK(default)
AT+CALCFLAG =2	Set the calculate flag to 2.	OK

**Downlink Command:**

- **Example:** 0XA5 01 // Same as AT+CALCFLAG =1

### 3.3.10 Set count number

Feature: Manually set the count number

In CPL01 work mode, the Total\_pulse set by the "AT+SETCNT=1,xx" command.

In CPL03 work mode, the Port1\_Total\_pulse(PA8) set by the "AT+SETCNT=1,xx" command.

**AT Command: AT+SETCNT**

Command Example	Function	Response
AT+ SETCNT =1,100	Set the count number to 0.	OK
AT+ SETCNT =2,0	Set the count number to 100.	OK
AT+ SETCNT =3,50	Set the count number to 50.	OK

**Downlink Command:**

0xA6 01 00 00 64 ==> AT+SETCNT=1,100

0xA6 02 00 00 00 ==> AT+SETCNT=2,0

0xA6 03 00 00 32 ==> AT+SETCNT=3,50

**3.3.11 Clear all counter values**

Feature: Manually clear all counter values

**AT Command:**

Command Example	Function	Response
AT+CLRC	Set all counter values to 0.	OK

**Downlink Command:** 0xA6 01

**3.3.12 Count Mod**

Feature: Manually set the count mode.

**AT Command:**

Command Example	Function	Response
AT+COUNTMOD=0	the count value keeps accumulating mode	OK(default)
AT+COUNTMOD=1	the count value will be reset after each TDC time(Last Close Duration Reset after each uplink)	OK

**Downlink Command:**

Example1: 0B 00 => AT+COUNTMOD=0

Example2: 0B 01 => AT+COUNTMOD=1

**3.3.13 Work Mod**

Feature: Manually set the work mode.

**AT Command:**

Command Example	Function	Response
AT+MOD=1	Set the Real-Time Open/Close Status mode(CPL01).	OK(default)
AT+MOD=2	Set the 3 pulse mode(CPL03).	OK

**Downlink Command:**



Example1: 0A 01 => AT+MOD=1

Example2: 0A 02 => AT+MOD=2

### 3.3.14 Set Time Sync Mode

Feature: Enable/Disable Sync system time via LoRaWAN MAC Command (DeviceTimeReq), LoRaWAN server must support v1.0.3 protocol to reply to this command.

SYNCMOD is set to 1 by default. If user wants to set a different time from the LoRaWAN server, the user needs to set this to 0.

#### AT Command:

Command Example	Function	Response
AT+SYNCMOD=1	Enable Sync system time via LoRaWAN MAC Command (DeviceTimeReq) The default is zero time zone.	OK(default)
AT+SYNCMOD=1,8	Enable Sync system time via LoRaWAN MAC Command (DeviceTimeReq) Set to East eight time zone.	OK
AT+SYNCMOD=1,-12	Enable Sync system time via LoRaWAN MAC Command (DeviceTimeReq) Set to West Twelve Time Zone.	OK

#### Downlink Command:

```
0x28 01 // Same As AT+SYNCMOD=1
0x28 01 08 // Same As AT+SYNCMOD=1,8
0x28 01 F4 // Same As AT+SYNCMOD=1,-12
0x28 00 // Same As AT+SYNCMOD=0
```

## 4. Battery & Power Consumption

CPL03-LB use ER26500 + SPC1520 battery pack. See below link for detail information about the battery info and how to replace.

[Battery Info & Power Consumption Analyze](#) .

## 5. OTA Firmware update

User can change firmware CPL03-LB to:

- Change Frequency band/ region.
- Update with new features.
- Fix bugs.

Firmware and changelog can be downloaded from : [Firmware download link](#)

Methods to Update Firmware:

- (Recommended way) OTA firmware update via wireless : <http://wiki.dragino.com/xwiki/bin/view/Main/Firmware%20OTA%20Update%20for%20Sensors/>
- Update through UART TTL interface : [Instruction](#).

## 6. FAQ

### 6.1 AT Commands input doesn't work

In the case if user can see the console output but can't type input to the device. Please check if you already include the **ENTER** while sending out the command. Some serial tool doesn't send **ENTER** while press the send key, user need to add ENTER in their string.

### 6.2 How to Connect Dry contacts or Wet Contacts

CPL03-LB can only be connected to dry contacts by default, and the wiring method is to connect the two ports of dry contacts to the VDD pin and pulse input pin of CPL03-LB respectively.

If you want to connect a wet contact, you need to change the original wiring method. The wiring method is that the GND of the wet contact is connected to the GND of CPL03-LB, and the pulse output is connected to the pulse pin, but the pulse output voltage of the wet contact must be less than 3.6V.

### 6.3 What is the maximum total number of pulses for CPL03? What happens after the maximum total number of pulses is reached?

The maximum total number of pulses for CPL03 is three bytes FF FF FF (16,777,215)  
The count is reset when the maximum total number of pulses is reached

## 7. Order Info

Part Number: **CPL03-LB-XXX**

**XXX**: The default frequency band

- **AS923**: LoRaWAN AS923 band
- **AU915**: LoRaWAN AU915 band
- **EU433**: LoRaWAN EU433 band
- **EU868**: LoRaWAN EU868 band
- **KR920**: LoRaWAN KR920 band
- **US915**: LoRaWAN US915 band
- **IN865**: LoRaWAN IN865 band
- **CN470**: LoRaWAN CN470 band

## 8. Packing Info

**Package Includes:**

- CPL03-LB LoRaWAN Pulse/Contact Sensor

**Dimension and weight:**

- Device Size: cm
- Device Weight: g
- Package Size / pcs : cm
- Weight / pcs : g

## 9. Support

- Support is provided Monday to Friday, from 09:00 to 18:00 GMT+8. Due to different timezones we cannot offer live support. However, your questions will be answered as soon as possible in the before-mentioned schedule.
- Provide as much information as possible regarding your enquiry (product models, accurately describe your problem and steps to replicate it etc) and send a mail to [Support@dragino.cc](mailto:Support@dragino.cc).