

	1	2	3	4	5	6	7	8	9	10	11	12	13	14
A					134,5 W Notebook-Netzteil - Anschlüsse: Schutzkontaktstecker (Typ F, CEE 7/7), DC-Buchse (universell, 2-Pin), USB-Buchse - Eingang: 100-240 V ~, 50/60 Hz, 1,7 A - Ausgänge DC: 12,0 V ---, 8,5 A, 102,0 W 14,0 V ---, 7,0 A, 98,0 W 15,0 V ---, 7,0 A, 105,0 W 16,0 V ---, 6,5 A, 104,0 W 18,0 V ---, 6,5 A, 117,0 W 18,5 V ---, 6,0 A, 111,0 W 19,0 V ---, 6,0 A, 114,0 W 19,5 V ---, 6,0 A, 117,0 W 20,0 V ---, 6,0 A, 120,0 W 22,0 V ---, 5,5 A, 121,5 W 24,0 V ---, 5,5 A, 132,0 W - Ausgang USB: 5,0 V ---, 0,5 A, 2,5 W - Ø Effizienz im Betrieb: 87,1 % - Effizienz bei geringer Last (10 %): 85,5 % - Leistungsaufnahme bei Nulllast: 0,24 W - Kabellänge AC: 1,2 m - Kabellänge DC: 1,8 m - Gewicht: 857 g (ohne Adapterstecker und AC-Kabel) - Konformität: RoHS				134,5 W Notebook Power Supply - Connectors: Safety power plug (Type F, CEE 7/7), DC socket (universal, 2-Pin), USB socket - Input: 100-240 V ~, 50/60 Hz, 1.7 A - Output DC: 12.0 V ---, 8.5 A, 102.0 W 14.0 V ---, 7.0 A, 98.0 W 15.0 V ---, 7.0 A, 105.0 W 16.0 V ---, 6.5 A, 104.0 W 18.0 V ---, 6.5 A, 117.0 W 18.5 V ---, 6.0 A, 111.0 W 19.0 V ---, 6.0 A, 114.0 W 19.5 V ---, 6.0 A, 117.0 W 20.0 V ---, 6.0 A, 120.0 W 22.0 V ---, 5.5 A, 121.5 W 24.0 V ---, 5.5 A, 132.0 W - Output USB: 5.0 V ---, 0.5 A, 2.5 W - Ø active efficiency: 87.1 % - Efficiency at low load (10 %): 85.5 % - No-load power consumption: 0.24 W - Cable length AC: 1.2 m - Cable length DC: 1.8 m - Weight: 857 g (without adapter plugs and AC cable) - Conformity: RoHS				A	
B					B									
C					C									
D					D									
E					E									

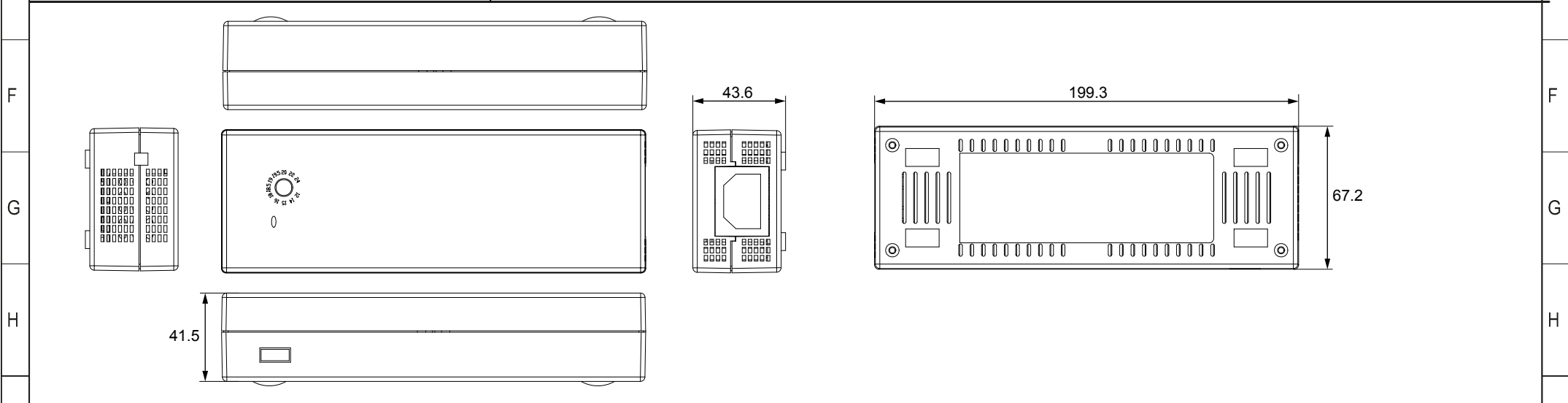

I	Änderungen		Datum	Name	Bezeichnung	Blatt
	Datum	Name	gez.: 18.11.2020	aw	NTS 134.5 W multi USB EuP 8.5A	1/2
			gepr.: 18.11.2020	aw		
			Norm:	Änderungen vorbehalten / Subject to change		Zeichnungs-Nr.: 20113253

1 2 3 4 5 6 7 8 9 10 11 12 13 14

Adapterstecker / Adapter plugs

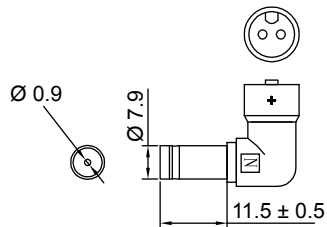

Adapterstecker 1 / Adapter plug 1
 Typ „L“ / Type „L“
 Material: PVC 20p, schwarz / Material: PVC 20p, black

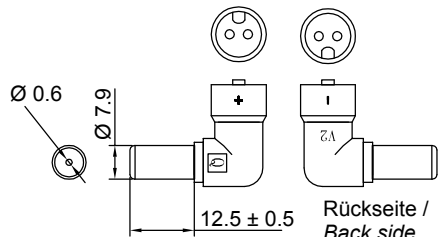

Adapterstecker 2 / Adapter plug 2
 Typ „L“ / Type „L“
 Material: PVC 30p, schwarz / Material: PVC 30p, black

Rückseite /
 Back side

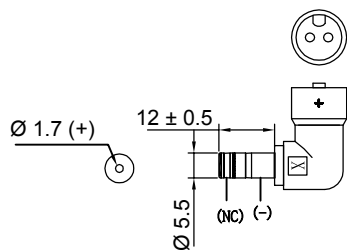

Adapterstecker 3 / Adapter plug 3
 Typ „L“ / Type „L“
 Material: PVC 20p, schwarz / Material: PVC 20p, black

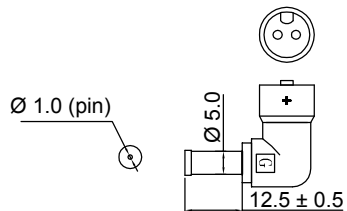

Adapterstecker 4 / Adapter plug 4
 Typ „L“ / Type „L“
 Material: PVC 20p, schwarz / Material: PVC 20p, black

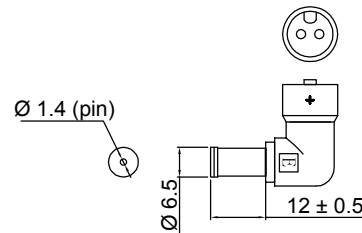

Adapterstecker 5 / Adapter plug 5
 Typ „L“ / Type „L“
 Material: PVC 20p, schwarz / Material: PVC 20p, black

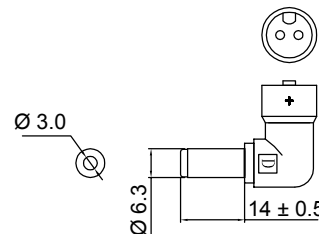

Adapterstecker 6 / Adapter plug 6
 Typ „L“ / Type „L“
 Material: PVC 20p, schwarz / Material: PVC 20p, black

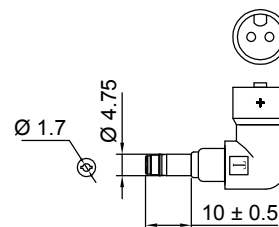

Adapterstecker 7 / Adapter plug 7
 Typ „L“ / Type „L“
 Material: PVC 20p, schwarz / Material: PVC 20p, black

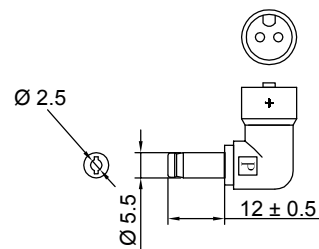

Adapterstecker 8 / Adapter plug 8
 Typ „L“ / Type „L“
 Material: PVC 20p, schwarz / Material: PVC 20p, black

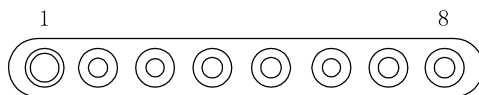

Halterung für Adapterstecker / Adapter plug holder

Änderungen

Änderungen		Datum	Name	Bezeichnung	Blatt
Datum	Name	gez.: 18.11.2020	aw	NTS 134.5 W multi USB EuP 8.5A	2/2
		gepr.: 18.11.2020	aw		
		Norm:		Zeichnungs-Nr.: 20113253	von
Änderungen vorbehalten / Subject to change					

1 2 3 4 5 6 7 8 9 10 11 12 13 14