



SE



NO

## DEVICE OPERATION MANUAL

### ZA, ZB and ZAH, ZBH Series Clock

#### 1. Introduction

The devices of ZA, ZB and ZAH, ZBH series are compact clocks with various configuration options. An intuitive user menu operated by a remote control allows you to fully customise the device.

The clock equipped with a network communication module allows remote configuration through the “Website” and time synchronization using the Internet time servers.

##### The clock enables:

- adjusting the time of the presentation: the clock, the date, and the temperature,
- adjusting the date format and the time format (12-hour or 24-hour),
- automatic and manual brightness control,
- working in the ECO mode allowing you to reduce power consumption,
- signaling 30 alarms through a built-in transmitter,
- choosing the shape of the display font,
- automatic time change from the standard time to the daylight saving time and from the daylight saving time to the standard time for various locations (Europe, Australia, the United States of America, Canada, Israel),
- GPS time synchronization (available with GPS option),
- synchronization using the NTP Internet servers (function available in the Ethernet option, requires the Internet access),
- Master Mode – a local time server compatible with NTP (function available in the Ethernet option, does not require the Internet access),
- synchronization with the local “Master Mode” server (function available in the Ethernet option, does not require the Internet access),
- configuration through the built-in “Website” (function available in the Ethernet option, does not require the Internet access).
- Display (content) synchronization in 3 modes (master, basic slave – master transmits only display information, full slave – master transmits display information and temperature) between any types of clocks (the function available in the Ethernet option, requires the access to the local network),
- setting a unit of measurement for the displayed temperature (Celsius degrees or Fahrenheit degrees),
- setting temperature offset,
- setting an individual clock name (the function available in the Ethernet option, requires the access to the local network),
- setting a language of WWW page (English or Polish, the function available in the Ethernet option, requires the access to the local network),
- stopwatch function, a timer counting up and a timer counting down. The end of counting is signalled by a built-in relay.

#### 2. Clock connectors

Fig. 1 shows the device connectors that are available after removing the housing cover.

**NOTE!** Removing the housing cover should be carried out with the power disconnected. This task must be performed with caution.

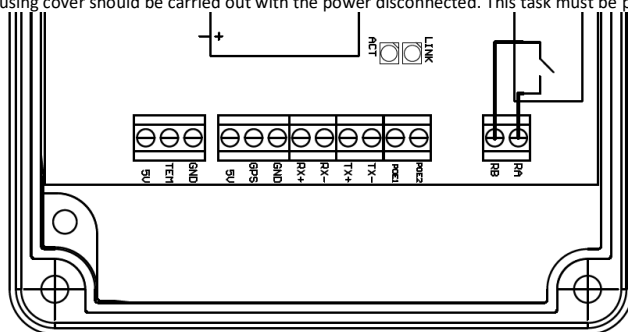

Fig. 1. Prestige Line clock connectors



SE



NO

Tab. 1. List of the Prestige Line clock connectors

Symbol	Function	Comments
RA, RB	Transmitter (alarm signalling device)	Closing contact, normally open, permissible load: - resistive: 5 A 250 VAC, 5A 30 VDC - inductive: 2 A 250 VAC, 2A 30 VDC
TX+	Ethernet (option)	Pin no. 1 of RJ-45 plug
TX-		Pin no. 2 of RJ-45 plug
RX+		Pin no. 3 of RJ-45 plug
RX-		Pin no. 6 of RJ-45 plug
POE1, POE2	PoE Lines (Power over Ethernet)	Compatible with standard IEEE 802.3at (PoE+, phantom (active) power)
GPS	GPS module signal	Works with GPS GM-2
TEM	Thermometer	-
5V	Power supply for the external modules	Power supply for the GPS and the thermometer
GND	System ground	-

### 3. Configuring the clock using the menu

The basic configuration method is by means of the remote control through the user menu.

Fig. 2 shows the remote control, along with the explanation of the function of each button. You enter the user menu using the MENU button. You navigate and modify the respective parameters using the buttons ↑, ↓, ← and →.

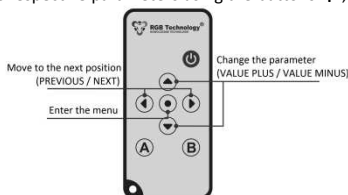

Fig. 2 Remote control

To add a remote control to the device:

- plug in device (if it was plugged in, unplug for about 10 seconds, then plug in again);
- direct remote control to the display, and enter the following sequence of buttons:

**A, B, ↓, A, ↓, ↓, B;**

The time between pressing next buttons must be shorter than 1s.

Word "SAVE" should appear for a moment (if the remote has already been in the memory of the clock, it should display "dub").

**NOTE!** Key sequence should be entered within 60 seconds after plug in.

Tab. 2 shows the structure of the main menu functions with the description.

Tab. 2. Main menu structure

Menu position	Function description
F1	Manual setting of the time and the date
F2	Configuration of the presented parameters
F3	Configuration of the date format
F4	Configuration of the time synchronization <sup>1</sup>
F5	Configuration of the display brightness
F6	Configuration of the alarms
F7	Configuration of the ECO mode
F8	Configuration of the display font
F9	Restoring the default settings
F10	Configuration of temperature offset
F11	Configuration of display synchronization
F12	Displaying information about the signal strength or disconnection of the GPS module
F13	Regional settings, such as location, time zones, daylight saving time/standard time
F14	Stopwatch function / timer counting up / timer counting down

<sup>1</sup> Option available in the variant equipped with the network synchronizations module or the GPS module.



SE



NO

To set the clock (enter the current date and time), you should:

- 1) Call the configuration menu by pressing the **MENU** key.
- 2) Select the „F1” function using the **↑** and **↓** keys and confirm it with the **→** key.
- 3) Using the **↑** and **↓** keys, modify the date and the time. Successively enter: the day of the month, the month, the year, the hour, the minute, and confirm the parameters with the **→** key.
- 4) After entering the complete time, the clock will automatically exit the menu.

**NOTE!** Before setting time from the website, the menu or automatically, configure regional settings.

**NOTE!** A blinking number indicates the time or date parameter which is being modified.

**NOTE!** To ensure that your device makes automatic changes between the daylight saving time and the standard time correctly, you should properly configure the time zone and activate taking into account the daylight saving time.

**NOTE!** When you set the clock on the last Sunday in March or on the last Sunday in October, take into account the information included in point 4. **Daylight Saving Time.**

To activate/deactivate displaying individual information and to modify the time of its presentation (the clock, the date, the thermometer), you should:

- 1) Call the configuration menu by pressing the **MENU** key.
- 2) Select the „F2” function using the **↑** and **↓** keys and confirm it with the **→** key.
- 3) To activate displaying the clock (**C**) set **Y** using the **↑** and **↓** keys and confirm it with the **→** key.
- 4) Next, using the **↑** and **↓** keys, modify the clock display time „Cd” and confirm it with the **→** key.
- 5) To activate the display of the date (**d**) set **Y** using the **↑** and **↓** keys and confirm it with the **→** key.
- 6) Next, using the **↑** and **↓** keys, modify the date display time „dd” and confirm it with the **→** key.
- 7) To activate the display of the thermometer (**t**) set **Y** using the **↑** and **↓** keys and confirm it with the **→** key.
- 8) Using the **↑** and **↓** keys modify the temperature display time „td” and confirm it with the **→** key.
- 9) The clock will return to the main menu, to exit the main menu, press the **←** key.

**NOTE!** If the respective parameter of the presentation (the clock, the date or the thermometer) is deactivated by setting **N**, the parameter presentation time step will be skipped.

To change the displayed date format, you should:

- 1) Call the configuration menu by pressing the **MENU** key.
- 2) Select the „F3” function using the **↑** and **↓** keys and confirm it with the **→** key.
- 3) Using the **↑** and **↓** keys, select your preferred format of displaying the date and confirm it with the **→** key.

	ZA/ZAH	ZB/ZBH
<b>dny</b>	DD-MM YYYY	DD-MM-YY
<b>ndy</b>	MM-DD YYYY	MM-DD-YY
<b>ynd</b>	YYYY MM-DD	YY-MM-DD
<b>ydn</b>	YYYY DD-MM	YY-DD-MM
<b>dn</b>	DD-MM	DD-MM
<b>nd</b>	MM-DD	MM-DD

- 4) Using the **↑** and **↓** keys, select your preferred format of displaying the time and confirm it with the **→** key.
  - tf 12** 12-hour format
  - tf 24** 24-hour format
- 5) Using the **↑** and **↓** keys, select your preferred leading zeros format of displaying the time and confirm it with the **→** key.
  - tLZ Y** time leading zeros format on
  - tLZ n** timeleading zeros format off

- 6) The clock will return to the main menu, to exit the main menu, press the **←** key.

To configure time synchronization or to activate the Master Mode<sup>2</sup>, you should:

- 1) Call the configuration menu by pressing the **MENU** key.
- 2) Select the **F4** function using the **↑** and **↓** keys and confirm it with the **→** key.
- 3) Using the **↑** and **↓** keys, select your preferred synchronization mode and confirm it with the **→** key.
  - S no** synchronization inactive (inactive Master Mode)
  - S GP** GPS satellite synchronization
  - S nt** NTP network synchronization
- 4) Using the **↑** and **↓** keys, activate/deactivate the Master Mode and confirm it with the **→** key.
  - tb y** Master Mode active
  - tb n** Master Mode inactive
- 5) The clock will return to the main menu, to exit the main menu press the **←** key.

**NOTE!** Before setting time from the website, the menu or automatically, configure regional settings

**NOTE!** The satellite synchronization requires the GPS module.

The network synchronization requires the network module and the Internet access.

<sup>2</sup> Option available in the variant equipped with the network synchronizations module or the GPS module.



SE



NO

**NOTE!** The Master Mode **cannot be activated**, if the reference clock does not have the active GPS or NTP synchronization.

To **activate the automatic display brightness control**, you should:

- 1) Call the configuration menu by pressing the **MENU** key.
- 2) Select the „**F5**” function using the **↑** and **↓** keys and confirm it with the **→** key.
- 3) Using the **↑** and **↓** keys, activate the automatic brightness control „**br A**” and confirm it with the **→** key.
  - br 1** Minimum brightness
  - ...
  - br 10** Maximum brightness
  - br A** Automatic brightness
- 4) Using the **↑** and **↓** keys, select your preferred automatic brightness control profile and confirm it with the **→** key.
  - Pr 1** Profile 1: Internal standard
  - Pr 2** Profile 2: Internal dynamic
  - Pr 3** Profile 3: External standard
  - Pr 4** Profile 4: External dynamic

To **set the display brightness manually**, you should:

- 1) Call the configuration menu by pressing the **MENU** key.
- 2) Select the „**F5**” function using the **↑** and **↓** keys and confirm it with the **→** key.
- 3) Using the **↑** and **↓** keys, activate your preferred brightness and confirm it with the **→** key.
  - br 1** Minimum brightness
  - ...
  - br 9** Maximum brightness
- 4) The clock will return to the main menu, to exit the main menu, press the **←** key.

To **enter or modify the alarm**, you should:

- 1) Call the configuration menu by pressing the **MENU** key.
- 2) Select the „**F6**” function using the **↑** and **↓** keys and confirm it with the **→** key.
- 3) Using the **↑** and **↓** keys, select one of the available alarms (**from A1 to A30**) and confirm it with the **→** key.
  - A 1** alarm 1
  - ...
  - A 30** alarm 30
- 4) Using the **↑** and **↓** keys, activate an alarm (**On Y**) and confirm it with the **→** key.
- 5) Using the **↑** and **↓** keys, modify the time of activating the alarm. Successively enter: first the hour, next the minute, and confirm the parameters with the **→** key.
- 6) Using the **↑** and **↓** keys, enter the alarm duration period in seconds (**t**) and confirm it with the **→** key.
- 7) Using the **↑** and **↓** keys, select your preferred alarm mode: **ALLd** (ever day) **SEld** (selected days) and confirm it with the **→** key.
- 8) If you choose the **SEld** mode (selected days), you should subsequently select the days in which the alarm is to be active (e.g. active on Monday **d1 Y**, inactive on Monday **d1 n**), every time proceeding by using the **→** key.
  - d1** Monday
  - d2** Tuesday
  - ...
  - d7** Sunday

To **activate the ECO mode of the display**, you should:

- 1) Call the configuration menu by pressing the **MENU** key.
- 2) Select the „**F7**” function using the **↑** and **↓** keys and confirm it with the **→** key.
- 3) Using the **↑** and **↓** keys, activate the ECO mode „**ECO Y**” and confirm it with the **→** key.
  - ECO Y** yes
  - ECO n** no
- 4) Using the **↑** and **↓** keys, modify the value of the entered time of **activating the clock display**, next confirm it with the **→** key.
- 5) Using the **↑** and **↓** keys, modify the value of the entered time of **deactivating the clock display**, next confirm it with the **→** key.
- 6) The clock will return to the main menu, to exit the main menu, press the **←** key.

**NOTE!** When the ECO mode is active (**ECO Y**) and the time of activating and deactivating the clock is the same, the clock will be **on** for 24 hours.

To **change the display font shape**, you should:

- 1) Call the configuration menu by pressing the **MENU** key.
- 2) Select the „**F8**” function using the **↑** and **↓** keys and confirm it with the **→** key.
- 3) Using the **↑** and **↓** keys, select your preferred font shape and confirm it with the **→** key.
  - Font1** rounded font



SE



NO

**Fnt2** seven-segment font

To restore factory settings of the clock by using the remote control, you should:

- 1) Call the configuration menu by pressing the **MENU** key.
- 2) Select the „F9” function using the **↑** and **↓** keys and confirm it with the **→** key.
- 3) Using the **↑** and **↓** keys, select **res Y** and confirm it with the **→** key.

**NOTE!** This function is used to fully restore factory settings, including resetting the alarm and making the default network configuration. This function doesn't reset a remote control codes. When the device is equipped with LAN module the network settings will be reset as well.

To set a unit of measurement for the displayed temperature and its offset using a remote control, you should:

- 1) Call the configuration menu pressing the **MENU** key.
- 2) Select the **F10** function using the keys **↑** and **↓** and confirm it with the key **→**.
- 3) Using the **↑** and **↓** keys, select a unit of measurement for the temperature and confirm it with the **→** key.

**tU °C** Celsius degrees

**tU °F** Fahrenheit degrees

- 4) Using the keys **↑** and **↓** select „Of Y” and confirm it with the key **→**.
- 5) Using the keys **↑** and **↓** set the appropriate temperature offset value within the range of  $\pm 9.9^{\circ}\text{C}$  and confirm it with the key **→**.

**Of Y** yes

**Of N** no

To configure the display (content) synchronization using a remote control, you should:

- 1) Call the configuration menu pressing the **MENU** key.
- 2) Select the **F11** function using the keys **↑** and **↓** and confirm it with the key **→**.
- 3) Using the keys **↑** and **↓** select „SC Y” and confirm it with the key **→**.
- 4) Using the keys **↑** and **↓** set the appropriate synchronization mode „SC Cb” (Slave - Content Basic), „SC Cf” (Slave - Content Full), „SC Sr” (Master – Server Content) and confirm it with the key **→**.

**NOTE!** The **only** result of the above configuration is setting / switching over to the selected operation mode. Full configuration of display synchronization requires configuring through the webpage. For a Slave device (basic or full), you should configure the IP address of the Master being the synchronization source.

To view information about the signal strength or disconnection of the GPS module using the remote control as follows:

- 1) Call the configuration menu pressing the **MENU** key.
- 2) Select the „F12” function using the **↑** and **↓** keys and confirm it with the **→** key.

**GP Un** GPS unconnected

**GP NO** GPS no signal

**GP PS** GPS poor signal

**GP GS** GPS good signal

To configure the clock location, the time zone, taking into account the daylight saving time, you should:

- 1) Call the configuration menu by pressing the **MENU** key.
- 2) Select the **F13** function using the **↑** and **↓** keys and confirm it with the **→** key.
- 3) Using the **↑** and **↓** keys, select the clock location and confirm it with the **→** key.
  - LO EU** location Europe
  - LO AU** location Australia
  - LO US** location the United States
  - LO CA** location Canada
  - LO IL** location Israel
- 4) Using the **↑** and **↓** keys, activate/deactivate taking into account the daylight saving time and confirm it with the **→** key.
  - dst y** yes
  - dst n** no
- 5) Using the **↑** and **↓** keys, activate/deactivate the time zone and confirm it with the **→** key.
  - G y** yes
  - G n** no
- 6) Using the **↑** and **↓** keys, select a time zone and confirm it with the **→** key.
  - 12** UTC zone -12:00
  - ...
  - 14** UTC zone +14:00
- 7) The clock will return to the main menu, to exit the main menu, press the **←** key.

**NOTE!** While configuring regional settings, the user must be aware of the time zones in the available locations.



SE



NO

**NOTE!** For the Polish official time, you should enter the UTC+1 (G 01) time zone and activate taking into account the daylight saving time „dst y”

**NOTE!** When you are setting the time zone, remember to maintain the conformity with the preset location. The illustration below will help you to choose the appropriate time zone.

To configure and activate the stopwatch/timer function, you should:

- 1) Call the configuration menu, by pressing the **MENU** key.
- 2) Select the **F14** function using the **↑** and **↓** keys and confirm it with the **→** key.
- 3) Using the **↑** and **↓** keys, select a particular special function of the clock and confirm it with the **→** key.

**STO Stopwatch**

**tiUP (Timer Up)** timer counting up from 0 to the preset value,

**tiDO (Timer Down)** timer counting down from the preset value to 0

- 4) After selecting the **STO** (stopwatch) function, press the **A** key to start counting.
- 5) After selecting the **tiUP** or **tiDO** function (timers), you should set the value to/from which the timer is supposed to count.

Setting the particular value on the hour/minute/second position is done using the **↑**, **↓** and **→** keys.

- 6) After configuring the selected timer mode, press the **A** key to start counting.

- 7) Functions of the keys:

- **A** – stop the counter/restart counting,
- **B** – restore initial counter value (active only when counting is stopped),
- **←** – return to the F14 menu.

- 8) Range/resolution dependent on the clock type:

- **ZAXX**: maximum value 99:59 (Minutes:Seconds)
- **ZBXX**: maximum value 99:59:59 (Hours:Minutes:Seconds)

**NOTE!** Timer settings begin from hours for the clocks of the ZBXX type and from minutes for the clocks of the ZAXX type.

**NOTE!** After exiting the F14 menu, counting is active in the background – after re-entering the previously selected function, the current counter value will be displayed regardless of the state (counting, stop).

**NOTE!** Activating any function such as counting, exiting the F14 menu and re-entering the F14 menu and selecting another function will stop counting and cause erasing the counter.

**NOTE!** Setting the timer counting values is possible only when the timers are stopped. In addition, setting the counting value to 00:00 or 00:00:00 (depending on the clock type) causes looping and resetting the counting value – protection against the 0 setting.

**NOTE!** Resetting the counter is possible only after having it stopped, otherwise pressing the **B** key will cause no action.

**NOTE!** When the selected timer finishes counting, the relay will be activated for 2 seconds. After deactivating the relay, recounting with the same settings starts after pressing the **A** key.

**NOTE!** After pressing the **→** key in the F14 menu, the name of the latest set function will be displayed, and, if no function has been set/activated before, the selection will begin from the stopwatch function "STO" by default.

To do a hardware restore factory settings of the clock, you should:

- 1) Disconnect the device from the power supply.
- 2) Make sure that the GPS connector cable is not connected (disconnect if there is).
- 3) Connect the GPS pin to GND pin inside the connector.
- 4) Switch on the power.
- 5) Wait (about 3 seconds) until the clock signals reset by flashing of middle-segment digits.
- 6) Disconnect the GPS pin and GND pin inside the connector

**NOTE!** This function is used to fully restore factory settings, including resetting the alarm and making the default network configuration. This function doesn't reset a remote control codes. When the device is equipped with LAN module the network settings will be reset as well.

## 4. Daylight Saving Time

### a) Europe

In accordance with EU Directive 2000/84/EC:

- the standard time is changed to the daylight saving time on the last Sunday in March (by adding one hour),
- the daylight saving time is changed to the standard time on the last Sunday in October (by taking away one hour).

Considering the above, in the countries following EU Directive 2000/84/EC, when the option of taking into account the daylight saving time is activated in the clock:

a) **On the last Sunday in March** there is no time interval between 01:00UTC + TimeZone and 01:59UTC + TimeZone. If you try to set the clock to the time within this interval, one hour earlier value is adopted, and it is assumed that the time has not yet been



SE



NO

changed to the daylight saving time. As a result, within the nearest 60 minutes, the clock will take into account the change to the daylight saving time and will add one hour automatically.

b) **On the last Sunday in October**, the time interval between 01:00UTC + TimeZone and 01:59UTC + TimeZone appears twice. If you set the clock to the time within this interval, the clock will be set to the time indicated by the user, and it is assumed that the time has already been changed to the standard time.

b) Australia

- the standard time is changed to the daylight saving time on the first Sunday in October at 2:00 AM of the local time (adding one hour),

- the daylight saving time is changed to the standard time on the first Sunday in April at 3:00 AM of the local time, taking into account DST, (taking away one hour).

The daylight saving time is not applied in North Australia, Queensland and West Australia. Setting time change, the user must consider the fact if the particular Australian territory (time zone) uses DST.

c) United States and Canada

- the standard time is changed to the daylight saving time on the second Sunday in March at 2:00 AM of the local time (adding one hour),

- the daylight saving time is changed to the standard time on the first Sunday in November at 3:00 AM of the local time, taking into account DST, (taking away one hour).

The states of Arizona, Puerto Rico, Hawaii, Virgin Islands and Samoa do not change time. Setting time change, the user must consider the fact if the particular state, situated in the respective time zone, uses DST.

a) Israel

- the standard time is changed to the daylight saving time on Friday before the last Sunday in March at 2:00 AM of the local time to 3:00 AM (adding one hour),

- the daylight saving time is changed to the standard time on the last Sunday in October at 2:00 AM of the local time to 1:00 AM (taking away one hour).

### Appendix A: Supporting the "Website"

The **ZA, ZB and ZAH, ZBH series clocks** equipped with the network communication module (Ethernet module) allow intuitive configuration through the built-in "Website".

To configure the network connection, follow the document **Network Card Configuration Manual**, to be downloaded from the following website:

<http://rgbtechnology.pl/soft/>

## 1. Connection with the device

The connection with the device is made through the Ethernet interface, while supporting the integrated „Website” is done via the Internet browser (recommended browser: Mozilla Firefox, version 16.0.2 or later).

To connect with the device, enter the IP address assigned to the device into the browser (default: **192.168.0.11**).

Then, the device will ask you to enter: username and password (default User: **admin**, Password: **dbps**).

**Note!** If you include a few clocks to the same network, the devices must be connected in succession and given a unique IP address, which will avoid an address conflict (initially all of them have the same default IP address).

## 2. Supporting the "Website"

The integrated "Website" consists of five webpages which allows you to configure various functions of the device.

**NOTE!** Always confirm the changes of the settings of the device parameters with the "Save" button.

### 2.1. Time tab

This tab allows you to configure the parameters connected with time.

- **Local date & time** – manual setting of the local time and date.
- **Remote time synchronization** – configuration of the remote synchronization of time, of the time zone, of allowing for daylight saving time, and of the IP addresses of NTP time servers.
- **Local Time synchronization** – configuring time synchronization (the time source, the time zone, the daylight saving time, the IP addresses of time servers, the Master Mode).

**Note!** To make the time synchronization using the NTP servers work, you need the proper (taking into account local network addresses) configuration of the following parameters: "IP Address", " Subnet mask", " Gateway" in the **Advanced** tab and the connection of the device to the Internet.

## 2.2. Display tab

This tab allows you to configure the parameters connected with the device display.



- **Format** – configuring the displayed functions and their duration (the clock, the date, and the thermometer) and the date format.
- **Brightness** – configuring the display brightness and activating the automatic brightness control.
- **Eco** – setting the energy saving mode (the time of activating the device, the time of deactivating the device).
- **Fonts** – selecting the display font.
- **Temperature offset** – configuration of the environment temperature offset.
- **Display synchronization** – configuration of the display (content) synchronization, of selecting the operation modes, and of the field of the master clock IP address (required for the Slave operation modes).

## 2.3. Alarms tab

This tab allows you to configure the parameters connected with the alarms.

- **Set alarm** – configuring a single alarm (activating, the operating time, the duration, the mode, the days of the week).
- **Alarms** – status of all available alarms.

The meanings of the alarm status symbols are described in **Tab. 3**.

Symbol	Colour	Meaning
	red	not set, inactive
	yellow	set, inactive
	green	set, active

**Tab. 3.** Alarm status symbols

## 2.4. Advanced tab

This tab allows you to configure the advanced parameters of the device.

**Clock name** – an individual clock name.

**Network** – network settings (the IP address, the subnet mask, the default gateway).

**Password** – setting the user password.

**Default settings** – restores the factory settings.

**NOTE!** The "Default settings" function fully restores the factory settings, including resetting the alarm and making the default network configuration.

## 2.5. Status tab

This tab allows you to read the device status.

**Date & time** – reading the time and the date.

**Sensors** – reading the sensors: the temperatures and the environment brightness.

**GPS status** – reading information about the signal strength or disconnection of the GPS module.

**Network** – reading the network interface configuration.

**Device** – reading the software version, hardware version, an individual clock name and product name.

## 3. Default network settings

**Tab. 4** shows the network settings of the Prestige Line clock. Restoring the factory settings is possible using the respective function in the user menu or in the "Website".

**Table 4.** Default network settings

Parameter	Default value
User	admin
Password	dbps
IP address	192.168.0.11
Subnet mask	255.255.255.0
Default gateway	192.168.0.1



## 4. Master Mode configuration

The ZA, ZB and ZAH, ZBH series clocks allow local synchronization of the slave clocks with the master clock. Tab. 5 shows a sample configuration of clocks.  
**NOTE!** Time server IP addresses can be entered by the user only via the "Website".

Tab. 5. Master Mode configuration

	Master clock (Master)	Slave clock (Slave)
Master Mode	active	inactive
Synchronization source	GPS or Ethernet	Ethernet
Comments	When you choose the Ethernet as the synchronization source, the Time server boxes from 1 to 5 should include sever addresses compatible with NTP.	In the Time server box 1, you should enter the master clock (Master) IP address. The Time server IP boxes from 2 to 5 should be filled in with the addresses 0.0.0.0

## 5. Changing the language of web page

To change the language, click at the bottom right corner on a flag symbolising the language. Available languages are Polish and English (default). After clicking on the desired flag, next to it should be displayed an information "Ustawiono język polski" or "Set english language", which means the correct language setting in the memory clock (feedback from the device).

## 6. Connecting LAN to the clock (in case of upgrading the clock)

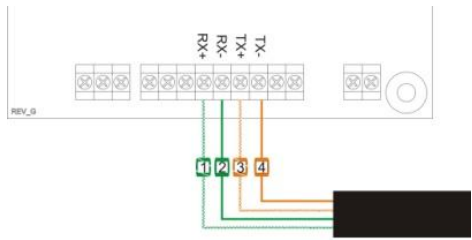

Fig. 1 LAN and CC Extender wiring diagram

Legend:

- Green-White -1- - RX+ wire
- Green-White -3- - TX+ wire
- Green -2- - RX- wire
- Orange-White -4- - TX- wire
- Orange -4- - TX- wire

### Appendix B: Selected accessories (sold separately)

#### 1. GPS GM-2 Receiver

The GPS GM-2 receiver (Fig. 1) is used to synchronize the real time in the RGB Technology products. The synchronization signal is sent from the satellite transmitters located on the circumterrestrial orbits. This kind of solution guarantees the synchronization of time in every place in the world. The device works properly on condition that the receiver module can "see" the sky.

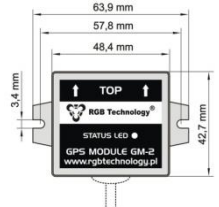

Fig. 1. Receiver module GPS GM-2 – overall view



Fig. 2. Receiver dimensions

The receiver is resistant to adverse atmospheric conditions – IP67 rating. To fasten the receiver, you can use the pressure-sensitive adhesive tape placed on the bottom of the receiver, use the band clips or screw it down with rawbolts – as required. It is essential to orientate the receiver properly – the arrows near the inscription "TOP" must be directed upwards. The receiver should be located in the open air to ensure the stable signal reception from the satellites. While searching for the correct location of the antenna, make sure that the receiver has enough time for reaction – after selecting the convenient location, place the antenna there and wait for a dozen or so minutes. It is a standard procedure during the „cold boot” of the GPS receiver. The GPS receiver has a LED informing about the work of the receiver.

LED	Meaning	What to do
doesn't shine	no power supply or the initialization of the receiver	if the diode doesn't start shining in a minute, check the receiver power supply
doesn't shine for 1 second / shines for a fraction of a second	no time synchronization, searching for the signal	if it lasts for more than 15 minutes, change the antenna location
shines for a second / doesn't shine for a fraction of a second	time is synchronized, searching for a stronger signal	if the diode doesn't start shining with continuous light in 15 minutes, change the antenna location
shines with continuous light	time is synchronized, very good signal	working correctly, no need for changes

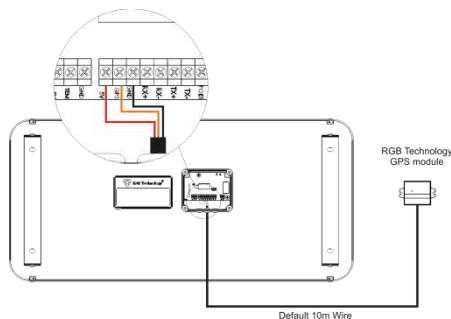

Fig. 3 Connection the GPS module to the clock

Legend:

Red - 0.25 mm<sup>2</sup> - 5VDC  
 Orange - 0.25 mm<sup>2</sup> - GPS signal cable  
 Black - 0.25 mm<sup>2</sup> - GND

Alternative color scheme:  
 Brown - 0.25 mm<sup>2</sup> - 5VDC  
 White - 0.25 mm<sup>2</sup> - GPS signal cable  
 Green - 0.25 mm<sup>2</sup> - GND

**NOTE!** Remember to enable time synchronization via GPS! See page 3 or 7.

## 2. Temperature probe

The optional temperature probe is available with two versions of a signal cable length 0.5m and 2m.

The probe enables measuring and displaying temperature in °C (Celsius) or °F (Fahrenheit). The detailed description of the temperature probe is available in the DTR documentation according to the catalogue index number.

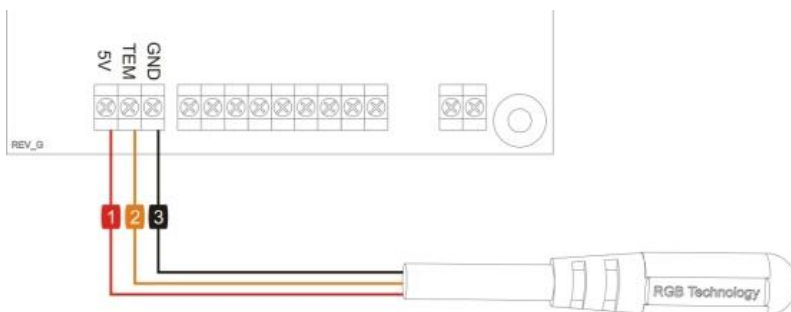

Fig. 4 Temperature probe and CC Extender wiring diagram

Legend:

Red -1- - 0.25 mm<sup>2</sup> - 5VDC  
 Orange -2- - 0.25 mm<sup>2</sup> - signal cable  
 Black -3- - 0.25 mm<sup>2</sup> - GND

Alternative color scheme:  
 Brown -1- - 0.25 mm<sup>2</sup> - 5VDC  
 White -2- - 0.25 mm<sup>2</sup> - signal cable  
 Green -3- - 0.25 mm<sup>2</sup> - GND

**NOTE!** Remember to enable temperature display! See page 3 or 7.

### 3. Buzzer

Optionally, the device is equipped with an audible signalling device (buzzer). The user may choose one of two signalling device versions:

- 1) volume of the audio signal at the level of 88dB;
- 2) volume of the audio signal at the level of 108dB.

The standard cable length is 10m.

The detailed description of the signalling device is available in the DTR documentation according to the catalogue index number.

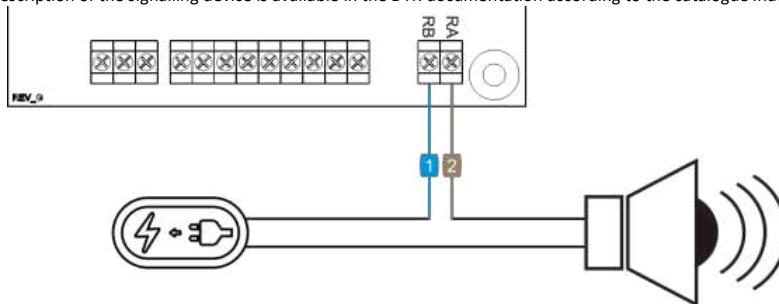

Fig. 5 Buzzer and CC Extender wiring diagram

Legend:

- Blue -1- - 0.5 mm<sup>2</sup> - contact "B" of the relay
- Brown -2- - 0.5 mm<sup>2</sup> - contact "A" of the relay

**NOTE!** Remember to configure alarms! See page 4 or 8.